

This article was downloaded by: [National Chiao Tung University 國立交通大學]

On: 24 April 2014, At: 23:29

Publisher: Taylor & Francis

Informa Ltd Registered in England and Wales Registered Number: 1072954 Registered office: Mortimer House, 37-41 Mortimer Street, London W1T 3JH, UK



Liquid Crystals

Publication details, including instructions for authors and subscription information:
<http://www.tandfonline.com/loi/tlct20>

Experimental investigation of liquid crystals in the millimetre frequency range

V.V. Meriakri^a, I.P. Nikitin^b, Ci-Ling Pan^b, Ru-Pin Pan^b, M.P. Parkhomenko^a & E.E. Chigryai^a

^a Kotelnikov Institute of Radio Engineering and Electronics, Russian Academy of Sciences, Fryazino, Moscow, Russia

^b National Chiao Tung University, Hsinchu, Taiwan

Published online: 15 Nov 2010.

To cite this article: V.V. Meriakri, I.P. Nikitin, Ci-Ling Pan, Ru-Pin Pan, M.P. Parkhomenko & E.E. Chigryai (2010) Experimental investigation of liquid crystals in the millimetre frequency range, *Liquid Crystals*, 37:11, 1453-1457, DOI: [10.1080/02678292.2010.520749](https://doi.org/10.1080/02678292.2010.520749)

To link to this article: <http://dx.doi.org/10.1080/02678292.2010.520749>

PLEASE SCROLL DOWN FOR ARTICLE

Taylor & Francis makes every effort to ensure the accuracy of all the information (the "Content") contained in the publications on our platform. However, Taylor & Francis, our agents, and our licensors make no representations or warranties whatsoever as to the accuracy, completeness, or suitability for any purpose of the Content. Any opinions and views expressed in this publication are the opinions and views of the authors, and are not the views of or endorsed by Taylor & Francis. The accuracy of the Content should not be relied upon and should be independently verified with primary sources of information. Taylor and Francis shall not be liable for any losses, actions, claims, proceedings, demands, costs, expenses, damages, and other liabilities whatsoever or howsoever caused arising directly or indirectly in connection with, in relation to or arising out of the use of the Content.

This article may be used for research, teaching, and private study purposes. Any substantial or systematic reproduction, redistribution, reselling, loan, sub-licensing, systematic supply, or distribution in any form to anyone is expressly forbidden. Terms & Conditions of access and use can be found at <http://www.tandfonline.com/page/terms-and-conditions>

Experimental investigation of liquid crystals in the millimetre frequency range

V.V. Meriakri^{a*}, I.P. Nikitin^b, Ci-Ling Pan^b, Ru-Pin Pan^b, M.P. Parkhomenko^a and E.E. Chigryai^a

^a*Kotel'nikov Institute of Radio Engineering and Electronics, Russian Academy of Sciences, Fryazino, Moscow, Russia;* ^b*National Chiao Tung University, Hsinchu, Taiwan*

(Received 2 July 2010; final version received 31 August 2010)

Dielectric properties of *n*-CB ($n = 5, 6, 7, 8$) liquid crystals (LCs) are investigated in the frequency intervals of 50–80, 120–160 GHz, and at 0.6 THz. The measurements are carried out in the millimetre wave range by the resonance method and with use of a reflectometer designed on the basis of a Michelson interferometer and quasi-optical metal-dielectric waveguides. Of most interest are the room temperature measurements of the birefringence of LCs. These measurements show that LCs can be used as polarisation transformers in the short wavelength region of the millimetre wave band and the long wavelength region of the sub-millimetre wave band.

Keywords: liquid crystals; dielectric properties; refractive index; birefringence

1. Introduction

Liquid crystals (LCs) are important objects of both physical and applied investigations. LCs represent complex heterogeneous media whose dielectric properties in the millimetre wave range have been studied insufficiently in spite of numerous publications devoted to their experimental investigation.

The basic factor that determines the interaction between electromagnetic waves and LCs in the millimetre wave range is the Debye relaxation [1]. There exist adequate methods for measuring the dielectric properties of LCs both at low and high frequencies in the microwave band (up to 5 GHz) [2] and at frequencies above 400 GHz, where the dielectric time-domain spectroscopy methods are effective [3]. However, there are few experimental data on the dielectric properties of LCs in the millimetre wave band (at frequencies from 30 to 300 GHz). These data are extremely important both for understanding the mechanisms of interaction between millimetre waves and LCs, especially near the phase transition points, and for the practical application of LCs, for example, in phase-shifters, lenses and polarisers [4, 5].

In the present study, we describe two sufficiently simple methods for measuring the dielectric properties of LCs which involve a measurement cell consisting of two plane-parallel plates of fused quartz and a plane (0.1–1) mm thick layer of LC sandwiched between these plates. These methods were used to measure the dielectric properties of LC samples of the homologous series *n*-CB ($n = 5, 6, 7, 8$) in the frequency interval 50–160 GHz.

2. Method using a resonance in an LC cell

The measurement cell has a symmetric shape and represents two plane parallel fused quartz plates of known thickness and refractive index, and an LC layer of thickness h_2 with unknown $n^*_2 = n_2 - ik_2$ (Figure 1). The LC layer was aligned by unidirectional rubbing of the inner surfaces of the quartz plates.

Here, 1 and 2 are fused quartz plates of thickness $h_{1,3}$ and known complex refractive index $n^*_{1,3} = n_{1,3} - ik_{1,3}$, $k_{1,3} \ll n_{1,3}$; the LC layer of thickness h_2 and of sought refractive index $n^*_2 = n_2 - ik_2$ is sandwiched between the quartz plates. For the structure shown in Figure 1, according to [6], the frequency spectrum of reflection is described by:

$$r(f) = \frac{\left(\frac{1-n_1^*}{1+n_1^*}\right) + r_2(f) \cdot \exp\left(2i\frac{2\pi f n_1^* h_3}{c}\right)}{1 + \left(\frac{1-n_1^*}{1+n_1^*}\right) + r_2(f) \cdot \exp\left(2i\frac{2\pi f n_1^* h_3}{c}\right)}, \quad (1)$$

where:

$$r_2(f) = \frac{\left(\frac{n_1^* - n_2^*}{n_1^* + n_2^*}\right) + r_1(f) \cdot \exp\left(2i\frac{2\pi f n_2^* h_2}{c}\right)}{1 + \left(\frac{n_1^* - n_2^*}{n_1^* + n_2^*}\right) \cdot r_1(f) \cdot \exp\left(2i\frac{2\pi f n_2^* h_2}{c}\right)},$$

$$r_1(f) = \frac{\left(\frac{n_2^* - n_1^*}{n_2^* + n_1^*}\right) + \left(\frac{n_1^* - 1}{n_1^* + 1}\right) \cdot \exp\left(2i\frac{2\pi f n_1^* h_1}{c}\right)}{1 + \left(\frac{n_2^* - n_1^*}{n_2^* + n_1^*}\right) \cdot \left(\frac{n_1^* - 1}{n_1^* + 1}\right) \cdot \exp\left(2i\frac{2\pi f n_1^* h_1}{c}\right)},$$

Here, f is frequency, i is the square root of -1 , and c is the speed of light.

*Corresponding author. Email: meriakri@ms.ire.rssi.ru

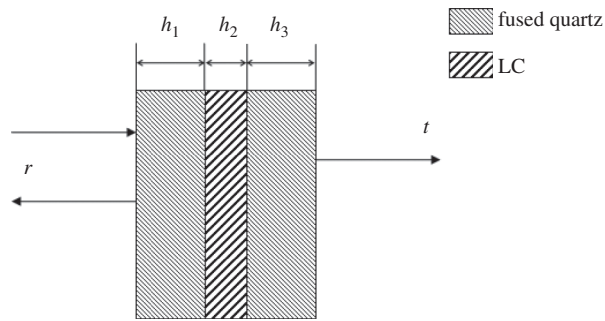

Figure 1. Cross-section of the measurement cell.

Using Equation (1), we calculated the frequency dependence of the power reflection coefficient ($R = 20 \log(|r|)$) of a typical three-layer structure shown in Figure 1), in which two layers (the first and the third) are fused quartz plates with refractive index $n_{1,3}^* = 1.95 - i \cdot 10^{-4}$ and the middle layer is a layer of LC with refractive index $n_2^* = 1.610 - i \cdot 9.3 \cdot 10^{-4}$.

This function is calculated for the parameters of the 5CB LC measured at frequency 59 GHz by the method described for the layer thicknesses of $h_{1,3} = 1.152$ and $h_2 = 0.533$ mm. The analysis of this function shows that the frequencies (f_m) and the magnitudes (R_m) of the even-order minima are determined by the refractive index n_2^* of the middle layer, whereas the frequencies of odd-order minima very weakly depend on the refractive index of the middle layer. The physics behind this fact is that the value of the electric field E in the LC layer is minimal for even-order minima and maximal for odd-order minima. The phenomenon considered underlies the method for determining the parameters of liquid crystals. Additional means for increasing the accuracy of measurements are provided by measuring the transmission through the measurement cell at the frequency f_m of the reflection minimum (T_{\max}). Since T_{\max} is sufficiently large (it varies from -0.2 to -0.5 dB), the effect of interference (spurious interference in the horn-sample region) is less than that when measuring the minimum of the reflection coefficient R_m for small values of the latter (from -30 to -40 dB).

3. Results of measurements

The method for measuring the reflection coefficient is implemented in the scheme involving a horn in front of which the measurement cell is placed (Figure 2).

To determine the refractive index of an LC, it is necessary to know the parameters of the quartz plates and the thickness h_2 of the LC layer. The refractive index of quartz can be measured by standard

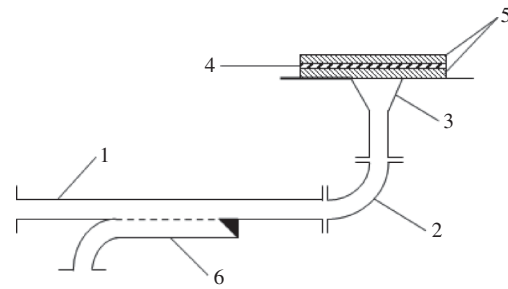

Figure 2. Scheme of the measurement set-up: 1 is a rectangular waveguide with mode H_{10} , 2 is a waveguide bend, 3 is a horn, 4 is a liquid crystal under test, 5 are fused quartz plates, and 6 is a directional coupler for measuring the reflection coefficient.

methods. The measurement error of the thickness is about $\pm 5 \mu\text{m}$.

For a specific three-layer structure, we should first calculate the calibration functions in the coordinates f_m, n_2 and R_m, k_2 (or T_{\max}, k_2) and, using the measured values of f_m and R_m , determine n_2 and k_2 . These functions for the first even-order minimum of reflection for the LC sample 5CB are shown in Figures 3 and 4.

Similar calculations can be performed for the second even minimum of reflection, and n_2 and k_2 can be determined for that frequency.

Using the method proposed, we measured the complex refractive indices of LCs n CB ($n = 5, 6, 7, 8$). The temperature dependence of n_e and n_o of these samples measured at frequency of 0.6 THz is presented in Figure 5. This shows that, for all samples in the nematic phase, Δn ranges from 0.1 to 0.16.

Table 1 compares the results of measurements carried out in the frequency interval 50–60 GHz at

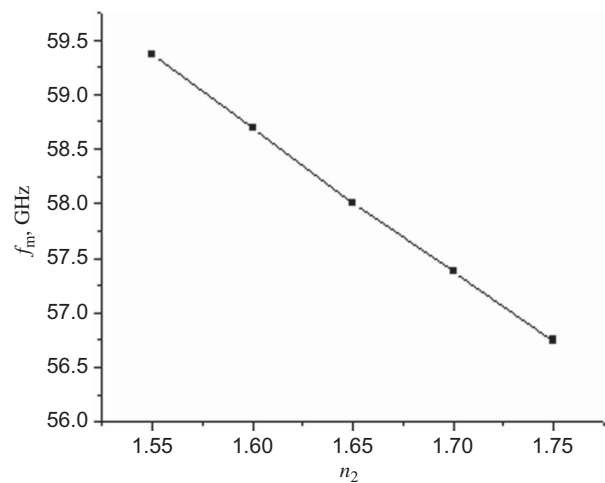

Figure 3. Calibration function in the coordinates f_m, n_2 .

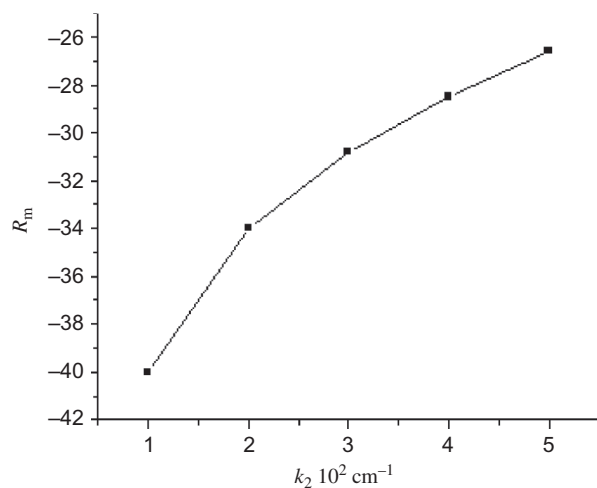

Figure 4. Calibration function in the coordinates R_m , k_2 .

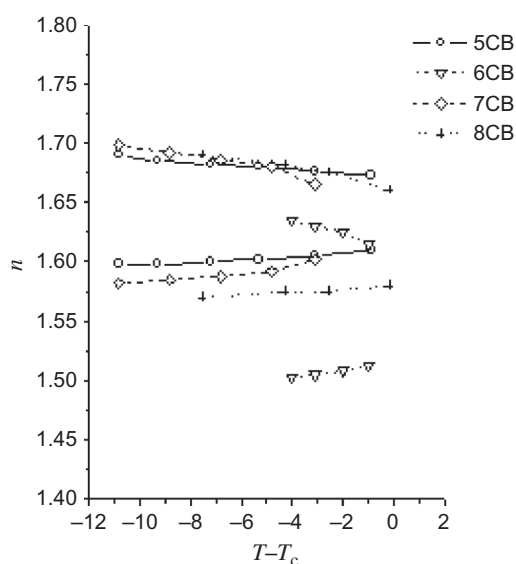

Figure 5. Temperature dependence of the refractive indices of n CB LCs. T_c is the temperature of transition to the liquid phase.

room temperature with those at 500 GHz [7]. One can see that the values of birefringence Δn measured at frequencies 50–60 GHz and 500 GHz are in good agreement.

The values of the imaginary part k_2 of the complex refractive index were the same (within the measurement accuracy of about 0.002) for both polarisations, virtually did not depend on temperature, and were equal to 0.010–0.015 for 5CB and 0.040–0.045 for 8CB at a frequency of 59 GHz.

The sample of 5CB has been investigated previously [2, 3]. The comparison with our data shows that the values of the real part of the complex refractive index for 5CB are somewhat less than the asymptotic

Table 1. Birefringence Δn measured at frequencies 50–60 GHz and 500 GHz.

LC	n_e^\dagger	n_o^\dagger	Δn^\dagger	n_e^\ddagger	n_o^\ddagger	Δn^\ddagger
5CB	1.71	1.60	0.11	1.66	1.57	0.09
6CB	1.69	1.59	0.10	1.69	1.59	0.10
7CB	1.69	1.58	0.12	1.66	1.55	0.11
8CB	–	–	–	1.62	1.57	0.05
E7	–	–	–	1.74	1.62	0.12

Notes: † Results of measurements at 500 GHz. ‡ Results of measurements at 50–60 GHz.

value of 1.69, measured at a frequency of 5 GHz [2], and is close to the value 1.65 at frequency 250 GHz, measured in [3] on a sample of 5CB containing 0.6 vol.% of 10 μm quartz particles. As for the value of k_2 , the data presented by Belyaev *et al.* [2] and Oh-e *et al.* [3] for frequencies of 0.065 and 250 GHz are 3–4 times greater than those obtained in our experiments. The measurement of 6CB in the frequency interval 150–160 GHz yielded the values $n_e = 1.69$ and $n_o = 1.60$, i.e. nearly the same values as those at 50–60 GHz. This means that the dispersion region of n_e and n_o in this LC is rather broad: it ranges from 50 to 160 GHz.

4. Method involving an interferometer

We developed a new method for measuring the dielectric properties of LCs in the short millimetre wave range and designed an experimental set-up that implements this method at wavelengths of about 2 mm (frequencies from 130 to 180 GHz). LC samples of the homologous series n CB ($n = 5, 6, 7, 8$) were investigated in the frequency interval 130–160 GHz.

The method employs a Michelson interferometer designed on a quasi-optical square metal–dielectric waveguide of cross-section 20 mm \times 20 mm [8]. A characteristic feature of such a waveguide is that it is a single-mode waveguide and that the field at the output is quiplane and has no appreciable side lobes. This allows high-precision measurements to be performed of the parameters of the plane-parallel dielectric plates placed behind the output aperture of the waveguide. The scheme of the interferometer is shown in Figure 6.

To determine the real part n_{LC} of the complex refractive index in the interferometer, we measured the phase shift $\Delta\varphi$ introduced by an LC sample. To this end, we placed the LC sample between the output aperture of arm 6 and the reflecting mirror 8 in arm 6 of the interferometer.

The measurements are carried out at the oscillator frequency f_e corresponding to an even minimum of the reflection coefficient of the LC sample when the

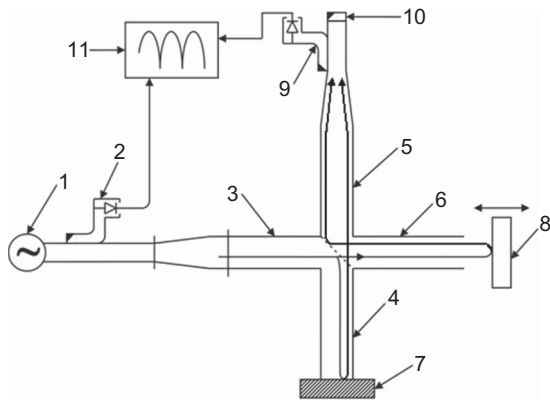

Figure 6. Scheme of the interferometer: 1 is a millimetre wave oscillator, 2 is the input directional coupler, 3 is the input arm of the interferometer, 4 is a side arm, 5 is the output arm connected to the indicator display, 6 is the working arm of the interferometer, 7 is a fixed mirror, 8 is a moving mirror, 9 is the output directional coupler, 10 is an absorber, and 11 is an interference pattern.

electric field vector of a wave in the waveguide is parallel to the extraordinary axis of the LC. A minimum of the signal in arm 5 of the interferometer is found by shifting the moving mirror. Then, we remove the LC sample from the interferometer and, shifting the moving mirror by Δl , again find a minimum of the signal in arm 5. The required parameter n_e is related to Δl by the formula:

$$[(n_e - 1)l_{LC} + (n_s - 1)l_s] = \Delta l + \frac{m\lambda_0}{2}. \quad (2)$$

Here l_{LC} is the known thickness of the LC layer, n_s and l_s are the known refractive index and the thickness of the quartz plates between which the LC layer is sandwiched, m is an integer, and λ_0 is the wavelength corresponding to $f_0 = c/\lambda_0$. The number m can easily be determined for known n_s , l_s , $l_{LC} \leq 0.5$ mm, and $n_{LC} \approx 1.5 - 1.7$.

To determine the refractive index n_e of the ordinary wave, we apply the same procedure after rotating the LC sample through 90° around the axis perpendicular to the plane of the sample. Figure 7 presents the refractive indices n_e and n_o of 6CB vs. temperature, measured with the use of the interferometer for two orthogonal polarisations at a frequency of 150 GHz.

This method allows the direct determination (without measuring n_e and n_o separately) of the birefringence $\Delta n = n_e - n_o$. To this end, at a fixed frequency, one determines the shift δl of the mirror in arm 2 when the LC sample in this arm is rotated from the position corresponding to the transmission of the extraordinary wave through the sample to the position when the

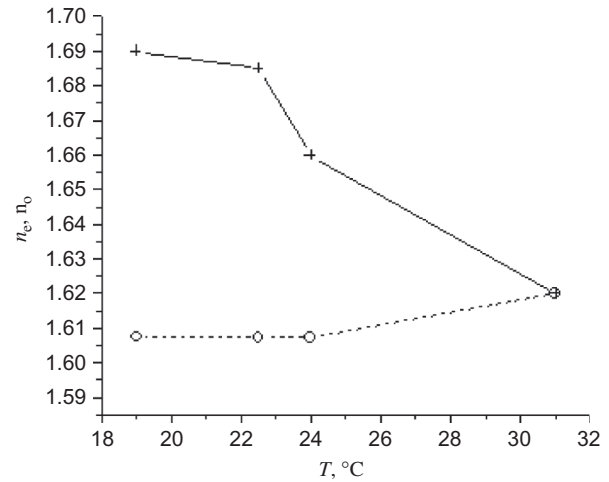

Figure 7. Refractive indices n_e and n_o of 6CB vs. temperature for two orthogonal polarisations at frequency 150 GHz.

Table 2. Birefringence of LC samples in the frequency interval 140–160 GHz and at 5 GHz.

LC	Δn^\dagger	Δn^\ddagger
5CB	0.17	0.14
6CB	0.14	0.08
7CB	0.22	0.09
8CB	0.12	0.08
E7	–	0.10

Notes: † Results of measurements at 5 GHz. ‡ Results of measurements at 140–160 GHz.

ordinary wave passes through the LC sample. Since $\Delta n \ll \lambda / l_{LC}$, we have

$$\Delta n = n_e - n_o = \frac{\delta l}{l_{LC}}. \quad (3)$$

Note that the accuracy of determining Δn is higher than the accuracy of determining n_e and n_o separately.

In the frequency interval 140–160 GHz, we measured the birefringence Δn of LC samples. Table 2 presents these results together with the same parameters measured at frequency of 5 GHz [2]. Table 2 shows that Δn at 140–160 GHz is smaller than that at 5 GHz, but agrees well with the results presented in Table 1.

5. Discussion

The results of our measurements carried out in the millimetre wave range can be compared with the results available in the literature only for 5CB; for other LC samples, there are no relevant data in the literature. The results for 5CB reported by Lim and Margerum [9] are $n_e = 1.60$ and $n_o = 1.52$ at

a frequency of 38 GHz and temperature $T = 25^\circ\text{C}$. These data significantly differ from the values $n_e = 1.71$ and $n_o = 1.62$ obtained at frequency 50 GHz by Nose *et al.* [10]. This fact may be attributed either to measurement errors or to the difference in the fabrication techniques of the LC samples. For example, we measured the parameters of two 5CB samples at frequencies 50 and 60 GHz. The data for one of these samples are shown in Table 1 ($n_e = 1.66$ and $n_o = 1.57$), while the data for the other are $n_e = 1.65$ and $n_o = 1.62$ (Figure 7); it can be seen that there is a significant difference in the values of n_e and n_o .

The birefringence Δn of LC samples calculated by Equation (3) in the frequency interval 140–160 GHz, as well as the results obtained by Vieweg *et al.* [7] at 500 GHz, can be used in the design of devices such as polarisation converters and phase shifters. For $\Delta n = 0.1$ and for imaginary part of the complex refractive index $k = 0.02$ (these or smaller values of k were measured in the millimetre wave range for almost all the LC samples investigated by us), such devices can have small longitudinal size (about 2–3 mm) and sufficiently low insertion loss (roughly about 1 dB or less) at frequencies of about 500 GHz.

6. Conclusions

We have developed two new methods for measuring the dielectric properties of LC samples in the millimetre wave range, designed set-ups operating at these frequencies, and investigated LC samples of the series n CB ($n = 5, 6, 7, 8$) at frequencies of 50–70 GHz and 130–180 GHz. The results indicate the existence of dispersion regions of n_e , n_o , and Δn in these LCs in the millimetre wave range. This fact should be taken into account when designing devices on LCs (first of all, polarisation converters) in the short wavelength region of the millimetre wave band and in the sub-millimetre

band. Some of the results of our investigations have been described in two conference presentations [11, 12] and in two journal articles [13, 14].

References

- [1] de Gennes, P.G.; Prost, J. *The Physics of Liquid Crystals*; Oxford University Press: London, 1993.
- [2] Belyaev, B.A.; Drokin, N.A.; Shabanov, V.F. *Phys. Solid State* **2005**, *47*, 765–768.
- [3] Oh-e, M.; Yokoyama, H.; Koeberg, M.; Hendry, E.; Bonn, M. *Optics Express* **2006**, *14*, 11433–11441.
- [4] Zhang, X.C.; Jin, Y.; Ma, X.F. *Appl. Phys. Lett.* **1992**, *61*, 2764–2766.
- [5] de Jue, W.H. *Physical Properties of Liquid Crystalline Materials*; Gordon & Breach: New York, 1980.
- [6] Born, M.; Wolf, E. *Principles of Optics*, 6th ed.; Pergamon: Oxford, 1980.
- [7] Vieweg, N.; Wilk, R.; Kloc, J.M.; Scheller, M.; Jansen, C.; Krumbholz, N.; Mikulics, M.; Koch, M. Presented at the 34th International Conference on Infrared, Millimeter, and Terahertz Wave, Busan, Korea, September 21–25, 2009.
- [8] Apletalin, V.N.; Kazantsev, Yu.N.; Solosin, V.S. *Radiotekhnika* **2005**, No. 8, pp 45–50 (in Russian).
- [9] Lim, K.; Margerum, J. *Proc. SPIE: Display Technologies* **1992**, *1815*, 99–105.
- [10] Nose, T.; Honma, M.; Nozokido, T.; Mizuno, K. *Appl. Optics* **2005**, *44*, 1150–1155.
- [11] Meriakri, V.V.; Pan, C.-L.; Pan, R.-P.; Parkhomenko, M.P.; Chigrai, E.E. Presented at the 4th International Conference on Advanced Optoelectronics and Lasers, Alushta, Crimea, Ukraine, September 29–October 4, 2008.
- [12] Meriakri, V.V.; Chigrai, E.E.; Nikitin, I.P.; Pan, C.L.; Pan, R.P.; Parkhomenko, M.P. Presented at the 34th International Conference on Infrared, Millimeter, and Terahertz Waves, Busan, Korea, September 21–25, 2009.
- [13] Meriakri, V.V.; Pan, C.-L.; Pan, R.-P.; Parkhomenko, M.P.; Chigrai, E.E. *Electromagn. Waves Electron. Syst.* **2008**, *13*, 90–93 (in Russian).
- [14] Meriakri, V.V.; Nikitin, I.P.; Pan, C.-L.; Pan, R.-P.; Parkhomenko, M.P.; Chigray, E.E. *Electromagn. Waves Electron. Syst.* **2009**, *14*, 73–75 (in Russian).