

# Comparative Analysis of Energy-Saving Techniques in 3GPP and 3GPP2 Systems

Jui-Hung Yeh, *Student Member, IEEE*, Jyh-Cheng Chen, *Senior Member, IEEE*, and Chi-Chen Lee

**Abstract**—Energy conservation is essential to wireless networks, particularly for third-generation (3G) and fourth-generation (4G) wireless systems, because high-speed data transmissions would rapidly exhaust the energy of a mobile station. This paper presents the details of energy-saving mechanisms for packet data services in two major standards, namely, the Third-Generation Partnership Project (3GPP) and the Third-Generation Partnership Project 2 (3GPP2). In addition to qualitative comparison, analytic models and quantitative comparison based on the energy-saving models are provided. The proposed analytic models analyze and quantify the energy consumption for bursty and streaming traffic in cdma2000 and wideband code division multiple access (WCDMA). The impacts of an inactivity timer on energy consumption and reconnection cost are demonstrated further by simulation and analysis. The analytic results could be used to suggest proper timer lengths that can balance the energy consumption and the reconnection cost. In addition to providing insights of the energy-conservation mechanisms of 3GPP and 3GPP2, which are often difficult to directly obtain from standards specifications, results shown in this paper are also practical for 3GPP and 3GPP2 operators to determine proper parameters for energy efficiency.

**Index Terms**—Energy efficiency, performance analysis, resource control, third-generation (3G) wireless systems, wireless communications.

## I. INTRODUCTION

THE RAPID expansion of wireless services, particularly wireless data services,<sup>1</sup> is motivating various energy-conservation mechanisms in prolonging the communication lifetime of a mobile station (MS). The design of energy-conservation techniques can be considered from different aspects. For instance, power control techniques, such as the

open-loop and close-loop power control techniques [1], are designed to adjust the transmitter power of an MS in code division multiple access (CDMA) cellular networks. Energy consumption during the transmission is, therefore, optimized. A survey of energy-saving techniques in various protocol layers in a communications system can be found in [2]. However, the study in [2] does not discuss third-generation (3G) systems. The analysis of energy efficiency in 3G Partnership Project (3GPP) or 3G Partnership Project 2 (3GPP2) can be found in [3]–[7]. In [3] and [4], only the energy-saving mechanisms in 3GPP are discussed and analyzed. Reference [5] analyzes the discontinuous reception (DRX) mechanism, which conserves the energy of an idle MS in 3GPP networks. On the other hand, [6] models the energy-saving mechanisms in 3GPP2. Our earlier paper [7] provides systematic comparison and analysis of the energy-saving mechanisms of 3GPP and 3GPP2. Extended from [7], this paper compares and analyzes the details of energy-saving mechanisms for packet data services in 3GPP and 3GPP2. In addition to qualitative comparison, analytic models and quantitative comparison are provided. Based on the analysis, parameters that balance energy conservation and reconnection overhead can be determined systematically.

In this paper, we regard the *power saving* techniques as those that directly adjust the power of the transmitter, the receiver, or other electronic circuits to reduce the power usage. On the other hand, *energy-saving* techniques control the turned-on duration of the device to eliminate unnecessary transmission and reception time. In other words, *power saving and energy saving* can be regarded as *power level management and duty cycle management*, respectively. The key idea of energy saving is to release network resources and force an MS to enter *sleep mode* when there are no data to transmit or receive. Because the MS is not always *active*, energy is, therefore, conserved. However, studies have shown that the duration of establishing a new session could take a few seconds. To minimize the reconnection overhead, an MS listens to a *paging channel* with limited power when it is in the sleep mode. The network also stores the MS's profile with respect to the session. Thereby, a session could be reestablished without renegotiation and reconfiguration.

Compared with second-generation (2G) systems in which voice service is the major application, it is expected that 3G systems with high-speed packet data services will consume much more energy. It is relatively easy to quantify energy consumption for 2G systems because the channel rate is fixed essentially, and the communication is continuous in 2G systems. In 3G systems, however, the user behavior of multimedia services, which may affect the energy consumption, is considerably complex.

Session management can reduce the reconnection overhead that is introduced by the energy-saving mechanisms for an MS.

Manuscript received August 11, 2007; revised January 25, 2008 and March 8, 2008. First published April 18, 2008; current version published January 16, 2009. This work was supported in part by the National Science Council under Grant 96-2752-E-007-003-PAE, Grant 96-2219-E-007-010, and Grant 96-2213-E-007-016. The review of this paper was coordinated by Dr. E. Hossain.

J.-H. Yeh was with the Department of Computer Science, National Tsing Hua University, Hsinchu 30013, Taiwan. He is now with Realtek-NCTU Joint Research Center, National Chiao Tung University, Hsinchu 300, Taiwan (e-mail: jhyeh@wire.cs.nthu.edu.tw).

J.-C. Chen is with the Department of Computer Science, National Tsing Hua University, Hsinchu 30013, Taiwan, and also with the Institute of Communications Engineering, National Tsing Hua University, Hsinchu 30013, Taiwan (e-mail: jcchen@cs.nthu.edu.tw).

C.-C. Lee was with the Institute of Communications Engineering, National Tsing Hua University, Hsinchu 30013, Taiwan. He is now with MediaTek Inc., Hsinchu 300, Taiwan (e-mail: chichen.lee@mediatek.com).

Color versions of one or more of the figures in this paper are available online at <http://ieeexplore.ieee.org>.

Digital Object Identifier 10.1109/TVT.2008.923687

<sup>1</sup>This paper refers *data* services as all new types of services, including text, image, video, etc.

TABLE I  
ACRONYMS OF 3GPP TERMINOLOGIES

Abbreviation	Full name	Abbreviation	Full name
BMC	Broadcast/Multicast Control	PDCP	Packet Data Convergence Protocol
CCCH	Common Control Channel (logical channel)	PDP	Packet Data Protocol
CPCH	Common Packet Channel (transport channel)	PICH	Paging Indicator Channel (transport channel)
CS	Circuit Switched	PMM	Packet Mobility Management
DCH	Dedicated Channel (transport channel)	RA	Routing Area
DTCH	Dedicated Traffic Channel (logical channel)	RACH	Random Access Channel (transport channel)
DRX	Discontinuous Reception	RANAP	Radio Access Network Application part
FACH	Forward Access Channel (transport channel)	RLC	Radio Link Control
GMM	GPRS Mobility Management	RNC	Radio network Controller
Iu - PS	Interface between the RNS and the core network - Packet Switched part	RNS	Radio Network Subsystem
L1	Layer 1 (Physical Layer)	SCCP	Signaling Connection Control part
L2	Layer 2 (data link layer)	SM	Session Management
LA	Location Area	SMS	Short Message Service
MAC	Medium Access Control	SRNC	Serving RNC
MM	Mobility Management	Uu	Interface between the MS and the UMTS fixed network part
OSI	Open System Interconnection	URA	UTRAN Registration Area
PCH	Paging Channel (transport channel)	UTRAN	Universal Terrestrial Radio Access Network

Session management, which controls all activities on an *active* session, is critical to an MS to support *always on*. That is, an MS could transmit data as soon as possible whether it is dormant or not. To achieve this, the MS and the network need to keep several resources such as radio channels (for paging) and memory spaces. Also, profiles such as the MS's IP address, protocol configurations, and negotiated QoS parameters should be maintained. However, the primary energy consumption of an *always on* MS comes from the fact that the receiver and the transmitter turn on every now and then. Consequently, energy conservation should consider resource management and session management.

Various divergences exist between 3GPP and 3GPP2. This causes global roaming among different systems a challenge. The basic idea of energy conservation, however, is similar. The energy that is consumed depends on an MS's activity. The less active an MS is, less energy will be consumed. This paper presents comparative analysis of energy consumption in wideband CDMA (WCDMA)/3GPP and cdma2000<sup>2</sup>/3GPP2. The energy consumption of Web browsing and streaming video, two major high-speed packet data services, is quantified. According to the analytic models and the extensive simulations, we show that, for energy conservation, WCDMA provides a finer grain technique than cdma2000. Based on our results, we also demonstrate that a good configuration of timer length could optimize both energy efficiency and reconnection overhead.

The rest of this paper is organized as follows. Sections II and III describe the energy-conservation techniques in 3GPP and 3GPP2, respectively. Section IV provides qualitative comparison of energy-saving techniques that are developed in 3GPP and 3GPP2. The analytic and simulation models are depicted in Section V. Section VI illustrates the numerical results. Section VII concludes this paper.

## II. ENERGY CONSERVATION IN 3GPP

The primary specifications for resource management and session management of 3GPP in this paper can be found in [8]–[10]. Table I provides a list of 3GPP acronyms referred in this paper. In 3GPP, user equipment (UE)<sup>3</sup> may be ordered by the network to release radio resources, while the network detects that the activity of the UE becomes low. The detection of a low activity can be accomplished by an inactivity timer or through the measurement reported from the UE. The techniques involve the transition in the radio resource control (RRC) state machine, the packet mobility management (PMM) state machine, and the session management state machine. Fig. 1 illustrates the protocol stacks between the UE and a serving GPRS support node (SGSN; GPRS: General Packet Radio Service) in the  $I_u$  mode [8], [11]. The relationship between RRC, PMM,<sup>4</sup> and SM is also illustrated in Fig. 1. Both the UE and the network, which includes the radio access network (RAN) and the core network (CN), need to maintain pairs of identical and synchronized state machines.

The following sections discuss SM, PMM, and RRC in details. Various channels of WCDMA, i.e., the radio technology that is adopted in 3GPP, will be mentioned throughout the rest of this paper. Therefore, the channel structure of WCDMA is first presented in Section II-A.

### A. Channel Structure of WCDMA

There are *logical*, *transport*, and *physical* channels in WCDMA. Logical channels are further classified into two types—*control* channels for carrying control messages and *traffic* channels for carrying user data. Transport channels offer

<sup>2</sup>The primary focus of cdma2000 in this paper is cdma2000 1× EV-DV.

<sup>3</sup>The UE in 3GPP is equivalent to the MS in 3GPP2.

<sup>4</sup>PMM is the packet-switched part of *GPRS Mobility Management (GMM)*.

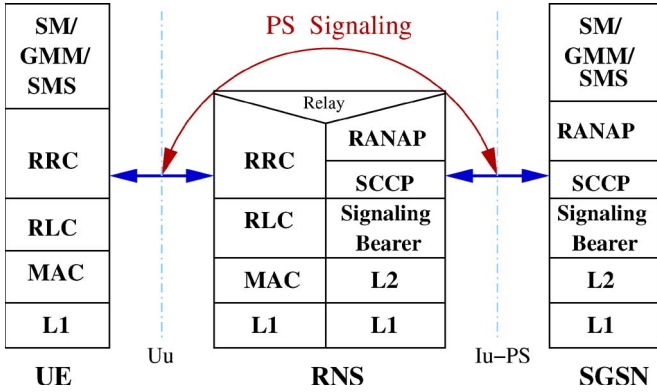

Fig. 1. 3GPP MS-SGSN in the Iu mode (control plane).

services from a physical layer to higher layers. There are two types of transport channels—*common* channels and *dedicated* channels. The word *dedicated* implies that this channel is only assigned to a single user. In contrast, *common* indicates that this channel is shared among several users. Physical channels are defined by a specific carrier frequency, a channelization code, etc. [12].

Additionally, three transport channels are introduced here: 1) a *forward access channel* (FACH), which is used for the UMTS Terrestrial Radio Access Network (UTRAN; UMTS: Universal Mobile Telecommunications System) to transmit messages to the UE; 2) a *paging channel* (PCH), which is monitored by the UE while it is in the sleep mode; and 3) a *dedicated channel* (DCH), which is assigned for a single user to transmit user traffic or signaling traffic. The channel mapping between logical channels and transport channels can be found in [13]. The mapping between transport channels and physical channels can be found in [14].

**B. SM State Machine**

SM supervises the packet data protocol (PDP), for instance, IP address, PDP context activation and deactivation. PDP contexts are mainly utilized for routing packet data from the UE. The UE and the network can transfer data to each other only after the PDP context has been activated. The SM state machine contains two major states—*active* (or *PDP-ACTIVE*) and *inactive* (or *PDP-INACTIVE*). Although there are three other states, they are transient states between *active* and *inactive* states. That is, only in the active state the PDP context is maintained by the UE and the SGSN. Then, a packet data session is alive when SM is in the active state [15].

**C. PMM State Machine**

PMM supports the mobility management functionality such as attach, detach, and routing area (RA) update of packet data services. The PMM state machine (also named as a packet switched (PS) state machine in [10]) consists of three states—PMM-DETACHED, PMM-IDLE, and PMM-CONNECTED states—as shown in Fig. 2.

- *PMM-DETACHED state*. In this state, no communication exists between the UE and the SGSN. The UE cannot

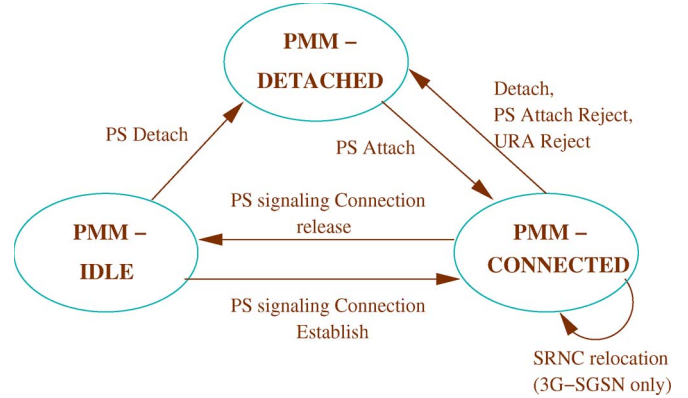

Fig. 2. PMM state machine.

be reached by any SGSN because the UE’s location is unknown. To communicate with the network, the UE should perform the *PS Attach* procedure.

- *PMM-IDLE state*. In this state, the SGSN is aware of the UE’s location with the precision of the RA [10]. The UTRAN, however, does not know the UE’s location because the RA is only maintained inside the CN. When the network wants to reach the UE, paging is needed in locating the position of the UE. The UE should perform RA update if it moves into a new RA. The UE and the SGSN maintain mobility management contexts in the PMM-IDLE and PMM-CONNECTED states.
- *PMM-CONNECTED state*. In this state, the UE is traceable by a serving radio network controller (RNC) at the *cell* level and an SGSN at the *RA* level. Only in this state does a PS signaling connection exist between the UE and the SGSN. The PS signaling connection that is specified in Fig. 1 comprises an RRC connection between the UE and the UTRAN. There is also a signaling connection control part (SCCP) connection between the UTRAN and the CN. The PS signaling is relinquished after the UE enters the RRC idle mode. Packet data can be transferred only in the PMM-CONNECTED state.

**D. RRC State Machine**

RRC performs radio-related functions, such as radio link establishment and maintenance between the UE and the UTRAN. RRC also performs control functions and signaling procedures between the upper and lower layers. This design leads RRC to be a coordinator in the UTRAN. Fig. 3 depicts the radio interface protocol architecture reference model [9]. The radios L1, L2, and L3 should not be considered the same as the lowest three layers of the Open System Interconnection (OSI) model. The L1 in Fig. 3 corresponds to OSI layer 1. The L2 and L3 in Fig. 3 correspond to OSI layer 2.

Fig. 4 depicts the main RRC modes, states, and state transitions [9]. In the RRC *idle* mode, no radio connection exists between the UE and the UTRAN for user traffic. The UE, however, can still be paged by the CN. In the *connected* mode, the UE and the UTRAN have at most one RRC connection regardless of how many signaling connections exist between

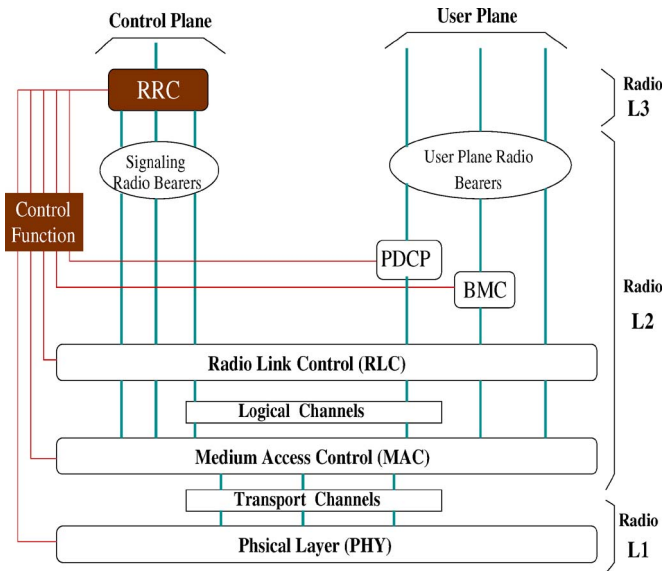

Fig. 3. Reference model of the radio interface protocol architecture.

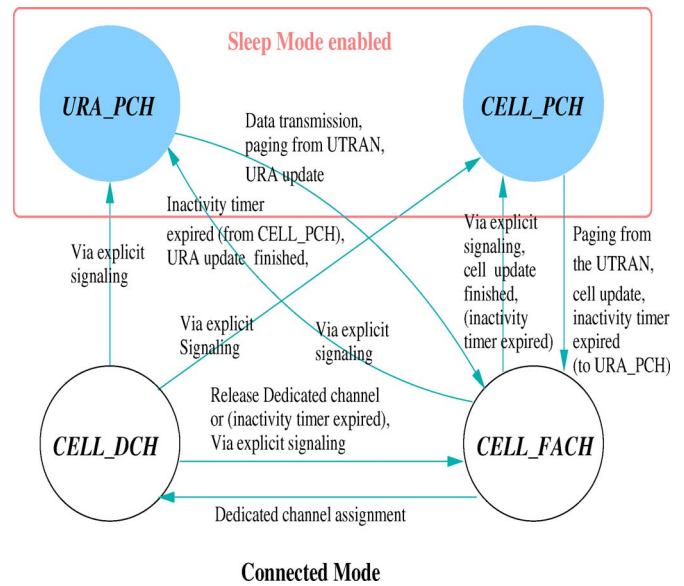

Fig. 5. RRC state transition in the connected mode.

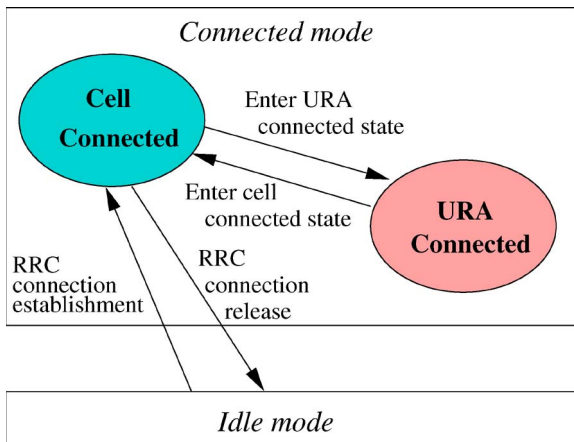

Fig. 4. RRC state machine.

the UE and the CN. The RRC connection is a conceptual connection; it actually consists of some contexts of the UE (similar to the PDP contexts of the UE that are maintained in the CN) that are maintained in the UTRAN. Signaling messages will be transmitted over signaling radio bearers.

The RRC state machine operates as two synchronized peer entities—one is in the UE side, and another is in the UTRAN side. The connected mode is further divided into two modes—*cell connected* and *UTRAN registration area (URA) connected*. In the cell-connected mode, the location of the UE is maintained by the UTRAN in the accuracy level of a cell. In the URA-connected mode, the UE is only known by the UTRAN in the URA level, a superset of multiple cells. We should notice that the UE should be paged when it is in the CELL\_PCH state of the cell-connected mode and the URA\_PCH state of the URA-connected mode before establishing a connection.

The detail of the RRC-connected mode is presented in Fig. 5, in which there are four states [9].

- **CELL\_PCH and URA\_PCH.** In these two states, the UE is known in the cell level in the CELL\_PCH state and

is known in the URA level in the URA\_PCH state. Because uplink (UE to UTRAN) activity in the states is not allowed, the UE could save its energy in these states. However, the UE should monitor the logical channel of the paging control channel such that the CN may page it when necessary. Moreover, the UE could use the optional *DRX* to efficiently conserve energy. The CELL\_PCH and URA\_PCH states are the only two states in the RRC-connected mode that are capable of entering the sleep mode and supporting the DRX mode. When the DRX mode is enabled, the UE needs only to monitor a short period in a paging cycle of the paging indicator channel (PICH) in the physical channel. A PDP context is still preserved in these two states [8]. If the UE needs to transmit messages to the network, it goes to the CELL\_FACH state. Because the PDP context is still retained, a session could be reconnected rapidly.

- **CELL\_FACH.** In this state, the UE is known in the cell level. The UE is assigned a default common or shared transport channel, which consumes less energy than the dedicated channel does. In this state, the UE should *continuously* monitor the FACH in the downlink. In the uplink, the UE may access the assigned common or shared channel [e.g., a random access channel (RACH) or a common packet channel (CPCH)] anytime according to the access protocol. The common and shared transport channels that are allocated in this state are suitable for bursty traffic such as Web browsing. The common transport channels like the CPCH that consumes less power and utilizes the spectrum more efficiently are suitable for a small or medium data amount [16]. The details of the channel types and the packet data could be found in [17].
- **CELL\_DCH.** In this state, the UE is also known in the cell level. Dedicated *physical* channels, however, are allocated to the UE in the uplink and the downlink. The dedicated channels are suitable for real-time services with large

traffic volume such as voice, streaming video, file transfer protocol (FTP) traffic, and Web traffic with large objects. In addition to the DCH, the shared transport channels, such as the downlink shared channel (DSCH), which can only be used in the CELL\_DCH state, are suitable for a medium or large data amount.

Fig. 5 presents the events that trigger the RRC state transitions. An inactivity timer (or a counter of cell update number) triggering the state transition from the CELL\_PCH state to the URA\_PCH state is explicitly pointed out in [9]. Because the UE has no uplink ability in the CELL\_PCH state, it must transit to CELL\_FACH first to register to the network before switching to the URA\_PCH state (see Fig. 5). In general, once the UE enters the CELL\_PCH state or the URA\_PCH state and needs to transmit or receive data, it must change to the CELL\_FACH state first.

When the UE is in the CELL\_DCH state and the CELL\_FACH state, it could transit to any other states of the connected mode through the signaling from the UTRAN triggered by events such as the expiration of inactivity timers or by network decisions according to measurement reports from the UE. The two events, i.e., an *inactivity timer expired* in parentheses (see Fig. 5), are implicit mechanisms in the UTRAN. In other words, they are possible ways, but not the only ways, and should be implementation issues in the UTRAN. For instance, the state transition from the CELL\_DCH state to the CELL\_FACH state may be triggered by procedures such as the *traffic volume measurement report* [9]. This measurement report monitors the traffic volume in the UE side and sets a threshold and a timer (similar to an inactivity timer). If the traffic is observed less than the predefined threshold for a period of time that is longer than the timer value, the UE should report to the UTRAN. After receiving this report from the UE, the UTRAN may order the UE to change its RRC state and change the type of its transport channel, e.g., changing from the DCH to the FACH in the downlink and from the DCH to the RACH in the uplink by signaling. All of the inactivity timers are network parameters and should be configured carefully.

Each RRC state characterizes how many radio resources the UE has. For example, the resources that are possessed by the UE in the CELL\_DCH state are more than the other three states. Consequently, it consumes the most energy. As mentioned above, the UE, the 3G SGSN, and the 3G Gateway GPRS Support Node will keep the PDP context even when the UE is in the sleep mode. By preserving the PDP context, the UE and the CN do not need to renegotiate for the parameters such as the IP address, the connection type, and the QoS profiles when the UE wakes up from the sleep mode and enters the CELL\_FACH state. Ultimately, the reconnection cost and the latency of the CELL\_FACH state are smaller than those of the CELL\_PCH state and the URA\_PCH state in the RRC-connected mode. In addition, the reconnection cost and the latency from the RRC idle mode to the RRC-connected mode are larger than those of any state in the RRC-connected mode. This is because the UE in the RRC idle mode must establish an RRC connection (e.g., establish the UE context [18]) before transmitting or receiving data.

TABLE II  
RRC AND CORRESPONDING PMM AND SM STATES

RRC State	Corresponding PMM State	Corresponding SM States
Connected mode - CELL_DCH	PMM - CONNECTED	Active
Connected mode - CELL_FACH	PMM - CONNECTED	Active
Connected mode - CELL_PCH	PMM - CONNECTED	Active
Connected mode - URA_PCH	PMM - CONNECTED	Active
Idle mode	PMM - IDLE/ PMM-DETACHED	Active / Inactive

### E. State Machines and Energy Conservation

To save energy, each state machine acts in a different role. The connected mode in the RRC state machine characterizes the communication capability of the UE and determines the level of activity that is associated with the UE. For example, only when the UE is in the CELL\_DCH state and the CELL\_FACH state will it assume the capability of uplink/reverse link transmission. That is, the activity of the UE/MS is higher than the rest of the states. Therefore, the level of activity implies the level of energy consumption.

The PMM state machine indicates the status of data transfer during a data session. For instance, the possibility of data transfer in the PMM-CONNECTED state is higher than that in the PMM-IDLE state. The SM state machine indicates whether the packet data session is still alive. Table II lists the corresponding states among the SM, PMM, and RRC state machines. Note that the transient states are not considered in Table II. For instance, before changing to the PMM-CONNECTED state, the PMM state machine should pass through the PMM-DETACHED first. This paper does not regard the PMM-DETACHED state as the corresponding state of the RRC-connected mode in such a transient stage. In general, SM is in the active state, whereas PMM is in the PMM-CONNECTED state, and RRC is in the connected mode. SM can be either in the active or inactive state, whereas the UE is in the PMM-IDLE state because the probability of data transfer is quite small. If SM is in the inactive state, the CN will determine that the UE is detached and deactivate the PDP context of the UE. This, however, may increase the reconnection latency and overheads.

The energy consumption could be roughly classified into three levels according to the RRC state machine. When the UE is in the CELL\_DCH state, the energy is consumed most. The CELL\_FACH state is the medium level. The rest of them, including the CELL\_PCH state, the URA\_PCH state, and the idle mode, consume less energy. The UE in the CELL\_FACH state could utilize the common channels. Thus, it may conserve more energy than that in the CELL\_DCH state, which uses DCHs. When the UE is in the CELL\_PCH state, the URA\_PCH state, or the idle mode, it could even conserve more energy by releasing the uplink channel and utilizing the DRX mode. Furthermore, the energy-conservation level in the URA\_PCH state is lower than that in the CELL\_PCH state if the mobility

is high. As mentioned above, SM is essential for compensating the penalty caused by energy-saving techniques of the RRC. The primary purpose of SM and PMM is to speed up the session reconnection. For example, PMM tracks the RA of the UE even when it is idle. It enables the CN to locate the UE quickly and accurately if the CN needs to transfer the data to the UE. SM, however, maintains the session profiles such as the PDP context of each of the UE to minimize the reconnection latency and overheads when the UE wakes up from the sleep mode. Before any data are transferred, the UE must set up radio and physical connections. The PMM and SM state machines along with the preservation of PS signaling efficiently reduce the time that is required to set up the radio and physical connections.

### III. ENERGY CONSERVATION IN 3GPP2

The design of a packet-switched network in 3GPP is quite different with the one in 3GPP2. The packet-switched part in the CN of 3GPP generally evolves from the GPRS system, whereas 3GPP2 leverages the mobile IP [19] to design its packet-switched CN. Thus, finding a one-to-one mapping in the packet-switched parts of 3GPP and 3GPP2 is a challenge. To make comparison, the mapping in this paper solely bases on the perspective of energy conservation with the structure presented in Section II. The mapping might not be perfectly applied to other aspects. The primary specifications of 3GPP2 that are referred in this paper are in [20]–[22]. Analogous to 3GPP, there are three primary state machines—the packet data session (PDS) state machine, the packet data service call control (PDSCC) state machine, and the MS layer 3 processing (MSL3P) state machine, which correspond to the SM state machine, the PMM state machine, and the RRC state machine, respectively, in Section II. The acronyms of 3GPP2 are summarized in Table III.

#### A. Channel Structure of *cdma2000*

Unlike WCDMA, there are two types of channels in *cdma2000*—logical channels and physical channels. A logical channel is a logical path that carries user traffic and signaling messages between peer entities such as base stations (BSs) and MSs. The forward link is a unidirectional radio link carrying traffic from BS to MS, whereas the direction of the reverse link is from MS to BS. In *cdma2000*, physical channels are defined in terms of radio frequency and code sequence. A physical channel is a physical path that transmits user data in signals. The higher layer (layer 3) may only use logical channels to transfer data to and from the lower layer (layer 2). The lower layer then decides to use which physical channel to transmit user data. A logical channel is represented by a three- or four-lowercase acronym with *ch* at the end. A physical channel is represented by the uppercase abbreviation. The definitions of *common* and *dedicated* are the same as those in 3GPP. For instance, logical channels of *f-dtch* and *r-csch* stand for *forward dedicated traffic channel* and *reverse common signaling channel*, respectively. The physical channel of *F-PCH* stands for a *forward paging channel*. *R-CCCH* represents a *reverse common control channel*.

TABLE III  
ACRONYMS OF 3GPP2 TERMINOLOGIES

Acronym	Full name
BSC	Base Station Controller
BS	Base Station
CCPD	Common Channel Packet Data
CPCH	Common Packet Channel
dpch	dedicated packet channel
f-dtch	forward dedicated channel
F-PCH	Forward Paging Channel
F-PDCH	Forward Packet Data Channel
IOS	Interoperability Specification
LAC	Link Access Control
MAC	Medium Access Control
NID	Network Identification
PCF	Packet Control Function
PDSN	Packet Data Service Node
PPP	Point-to-Point Protocol
PZID	Packet Zone Identification
QPCH	Quick Paging Channel
r-csch	reverse common signaling channel
R-CCCH	Reverse Common Control Channel
RLP	Radio Link Protocol
RN	Radio Network
SDB	Short Data Burst
SID	System Identification
SRBP	Signaling Radio Burst Protocol

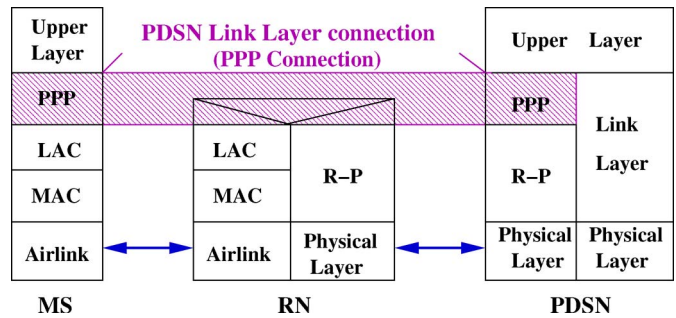

Fig. 6. Simplified 3GPP2 packet data service protocol stack.

#### B. PDS State Machine

This section first reviews the packet data service in 3GPP2 before examining the PDS state machine. Fig. 6 shows the simplified protocol stack of the packet data service. In the figure, a packet data serving node (PDSN) establishes, maintains, and terminates the data session, which essentially is a point-to-point protocol (PPP) session, to the MS. The RN consists of BSs, BS controllers (BSCs), and packet control functions (PCFs). As indicated in Fig. 7, a PCF relays packets to and from the PDSN. It also establishes, maintains, and terminates the layer 2 connections to the PDSN. The PCF and the PDSN are the primary components for the packet data service. To transmit or receive packet data, the MS must establish two types of connections—the radio connection from the MS to the BS and the BSC and the interoperability specification (IOS) connections [23], including connections from the BSC to the PCF and from the

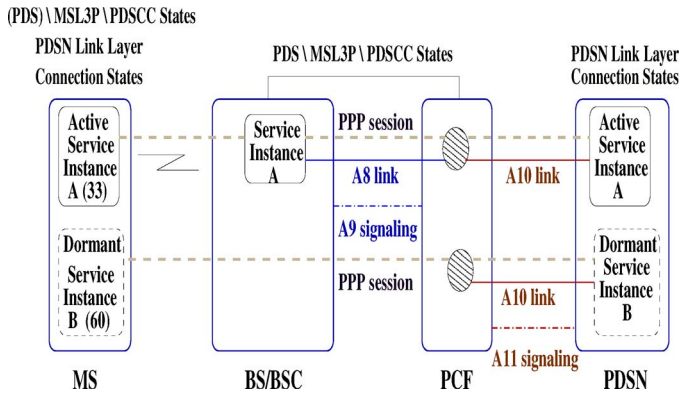

Fig. 7. IOS connection and service.

PCF to the PDSN. The PDS state machine defined in [22] primarily supervises IOS and PPP connections. Thus, it should be implemented in the BS/PCF. The IOS connections for packet data services between the BSC and the PCF are called A8 and A9 links, whereas the connections between the PCF and the PDSN are named as A10 and A11 links. The A8 and A10 links carry user data, whereas the A9 and A11 links carry signaling traffic. Each *active* service instance of the MS is assigned with an A8 connection and an A10 connection. On the other hand, each *dormant* service instance only maintains an A10 connection. That is, there is no actual connection between the PCF and the BSC. The A9 and A11 links are shared among service instances for signaling purposes to set up A8 and A10 connections.

The link layer connection of the PDSN depicted in Fig. 6 is open, while a packet data service option, which is also known as Service Option 33, is first connected. Service Option 33 is used for requesting packet data service through a PDSN. The link layer connection of the PDSN can be either in a *closed state* or an *opened state*. In the closed state, the PDSN does not have the state information of link layer connection for an MS. In contrast, the PDSN maintains the state information of a link layer connection for an MS, while it stays in the opened state. The packet data session is associated with a PPP session and will be terminated when all service instances are finished. To manage a packet data session, there are three PDS states.

- *Active/connected*. In this state, a physical traffic channel is utilized for data transmission between the MS and the BS. The PPP session is active in this state, while A8 and A10 links are established in the network. For each A8 connection, the BS keeps an independent packet data inactivity timer in this state.
- *Dormant*. In this state, no physical traffic channel is established by the MS, but the PPP link (the PDSN link layer connection) between the MS and the PDSN is maintained. The A8 link is released in this state, while the A10 link is preserved.
- *Null/inactive*. In this state, no physical traffic channel exists between the MS and the BS, and no PPP link exists between the PDSN and the MS.

Fig. 8 sketches the state machine of PDS. PDS states characterize the status of a packet session and maintain the corresponding information. From this perspective, PDS is analogous

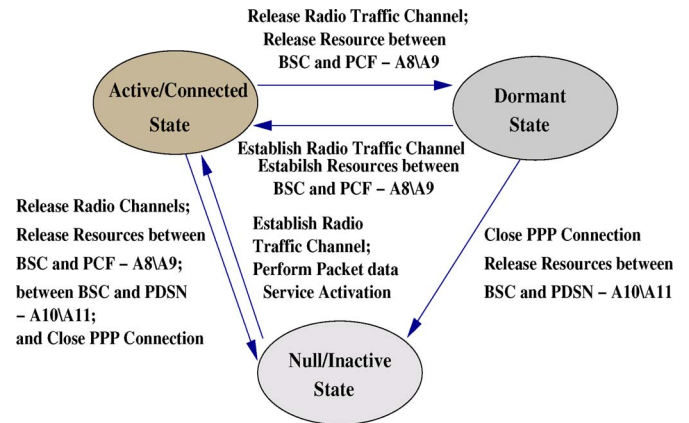

Fig. 8. PDS state transition.

to SM in 3GPP. However, PDS is involved in the procedure of a packet session handoff. The *dormant state* indicates that the activity of the MS is low, and the probability of data transfer is small. Thus, the PDS state is somewhat similar to PMM in 3GPP from this perspective. From the energy-conservation perspective, this paper regards the PDS state machine as a counterpart of the SM state machine in 3GPP because it primarily characterizes the status of PDS.

### C. PDSCC State Machine

The PDSCC state machine is utilized to support call control procedures of high-speed packet data service, i.e., Service Option 33, in the cdma2000 spread spectrum system.

- *Null state*. When the packet data service has not been activated, the PDSCC state machine is in the null state.
- *Initialization state*. In this state, the MS attempts to connect a packet data service option.
- *Connected state*. In this state, a packet data service option is connected. That is, user packet data are exchanged between the MS and the PDSN. The *inactivity timer* of the packet data service instance is activated by the MS in this state, and its value should not be less than 20 s [20]. Whenever a nonidle radio link protocol data frame is sent or received, the timer should be reset. The PDSCC function should enter the *dormant state* once the inactivity timer of the packet data service instance expires.
- *Dormant state*. In this state, the packet data service option is disconnected. That is, the radio resource that is used for traffic is relinquished. However, the PDSN link layer connection is still in the opened state to reduce the latency of switching from the dormant state back to the connected state. Upon entering the dormant state, the MS should store the current values of system identification (SID), network identification (NID), and packet zone identification (PZID). The combination of SID/NID/PZID triplet uniquely identifies the current location of the MS. Each PCF corresponds to a packet zone. If the packet zone reconnection (similar to the RA Update in 3GPP) is supported by the MS, the MS reconnects and updates the packet data service when it detects the change of the packet zone. Therefore, the MS could reduce the

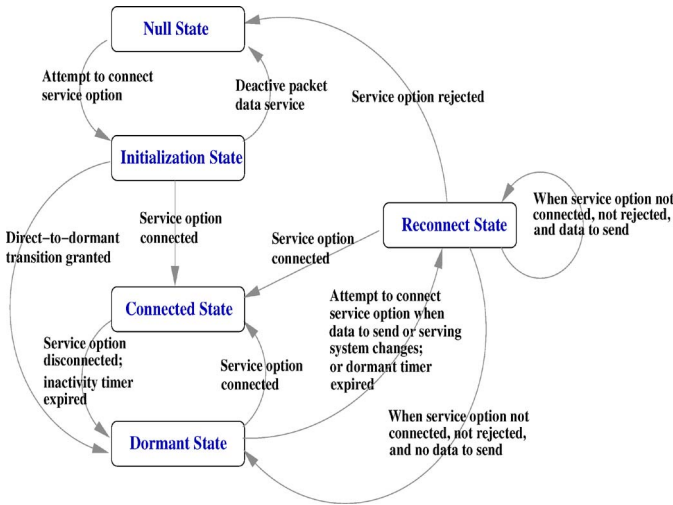

Fig. 9. PDSCC state machine in the MS.

reconnection delay because the network may predict the location of the MS more accurately.

In this state, the MS can also choose to use short data burst (SDB) [20] to send data whenever it has a small amount of data to send. Similar to the CPCH in 3GPP, the SDB is supported by the common channel packet data (CCPD) mode [22], which enables the data transfer over common channels without changing the state of the MS from the dormant state to the connected state.

- *Reconnect state.* In this state, the MS attempts to connect to a previously connected packet data service option. The MS retrieves the prestored service configuration without renegotiation if the network does not change the service configuration. The MS can either directly switch from the dormant state to the connected state or go through the reconnect state. The MS directly enters the connected state if the PDSN has data to transmit to the MS. Otherwise, if the MS has data to send, it must enter the reconnect state first. The detailed state transition is illustrated in Fig. 9.

Note that the PDSCC instance is created and then removed in the substates of MSL3P, which is explained in Section III-D. Compared with MSL3P, PDSCC serves in the lower layer because PDSCC performs the packet-related call control functions such as setting QoS parameters and service configuration in medium-access control and physical layers. Because the dormant state of the PDSCC state machine supports the packet zone reconnection, this paper considers the PDSCC state machine as a counterpart of the PMM state machine in 3GPP.

#### D. MSL3P State Machine

Fig. 10 [24] illustrates the cdma2000 layer structure and the corresponding OSI layers. The MSL3P state machine is part of the *upper layer signaling*, i.e., the signaling processing center that originates and terminates signaling data. Although Fig. 10 shows that the upper layer signaling may be mapped to OSI layers 3–7, it should be noticed that the upper layer signaling could be also in charge of cdma2000 signaling (e.g., direct signaling to the physical layer), which is not a conventional

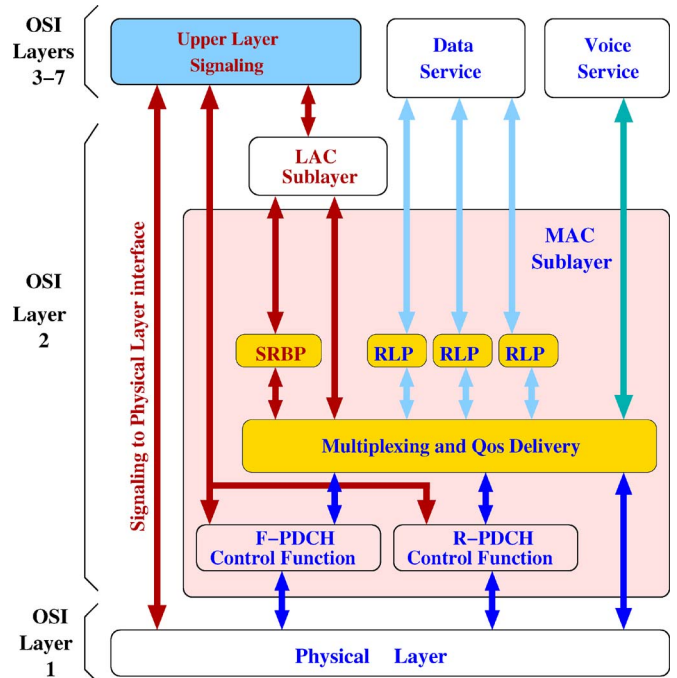

Fig. 10. cdma2000 layer structure.

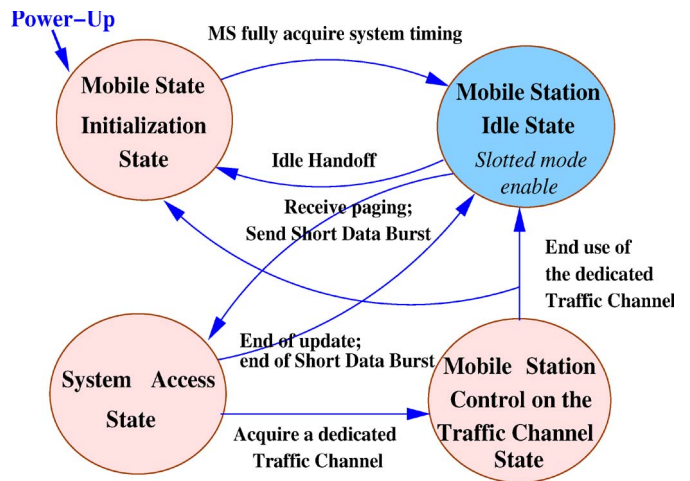

Fig. 11. State transition of MSL3P.

function of OSI layer 3 or other upper layers. The MSL3P characterizes the general status of the MS. For instance, by checking the MSL3P state, the CN or the RN may detect that the MS is in idle status or in traffic status. Consequently, different types of channels are used to communicate with the MS. Moreover, the MSL3P state machine is responsible for radio resource control, service configuration, and negotiation through various signaling protocols. Like RRC in 3GPP, only one synchronized pair of the MSL3P state machine will be maintained in the MS side and the network side. It represents the general status and communication capabilities of the MS. Hence, this paper regards MSL3P as the counterpart of RRC in 3GPP from the energy-conservation perspective.

Fig. 11 illustrates the state transition of MSL3P. In this paper, we focus on the characteristics of each state, particularly



the type of the radio channel that the MS can possess. The characteristics of the states are itemized as follows.

- *MS initialization state*. In this state, the MS first decides which system to use. If the selected system is a CDMA system, the MS needs to acquire system information and then synchronize to the CDMA system. If the MS selects an analog system to use, it begins the operation in the analog mode [21].
- *MS idle state*. In this state, the MS monitors messages that are received from the f-csch such as the paging channel. The MS can receive messages or an incoming call, and initiate a call or a message transmission.
- *System access state*. In this state, the MS sends messages to the BS by using the r-csch and receives messages from the BS through the f-csch. The MS enters this state mainly to acquire reverse channels to transmit messages to the BS.
- *MS control on the traffic channel state*. In this state, the MS communicates with the BS by using the f/r-dsch and the f/r-dtch. This state contains several substates to monitor the status of the dedicated channel that is utilized by the MS.

Similar to that in 3GPP, the MS possesses different types of channels depending on the MSL3P state in 3GPP2. For example, if the MS is in the *MS idle state*, it cannot utilize the r-csch unless it enters the *system access state*. Hence, the MS consumes more energy in the *system access state* than in the *MS idle state*. Upon entering the *MS idle state*, the MS could not change its state unless it was triggered by an event, such as paging. Unlike the *MS idle state*, the MS enters the *system access state* for certain purposes such as replying paging, sending SDB, or initiating services.

#### E. State Machines and Energy Conservation

Like the techniques in 3GPP, to make energy saving applicable, only one state machine of MSL3P that governs the energy consumption is not sufficient. It also needs the PDSCC state machine to monitor the activity of the packet data service. For retaining the session properties when the MS enters the dormant state, the PDS state machine is crucial during the whole session. Table IV lists the corresponding states between the three state machines. Analogous to Table II, the transient states are not considered in Table IV. When the MS is in the *MS initialization state* of MSL3P, the instances of PDSCC and PDS are not initiated yet. Therefore, the corresponding states of PDSCC and PDS are *non* in the table. When the MS is not communicating, generally, the MSL3P state machine is in the *MS idle state*. If there is no traffic channel or dedicated channel between the MS and the BS, both PDSCC and PDS state machines are in the *dormant state*. They are mapped to the *MS idle state* of the MSL3P state machine. The *initialization state* of PDSCC and the *null/inactive state* of PDS are mapped to the *system access state* of MSL3P because the MS needs to get the reverse link to send messages to the BS. The *dormant state* of PDS may also correspond to the *reconnect state* of PDSCC and the *system access state* of MSL3P. This is because that MS may use the CCPD mode (corresponding to SDB in Fig. 11) to send packets while staying in the *dormant state* of PDS.

TABLE IV  
MSL3P AND CORRESPONDING PDSCC AND PDS STATES

MSL3P State	Corresponding PDSCC State	Corresponding PDS State
MS Initialization State	non	non
MS Idle State	Dormant State	Dormant State
System Access State	Initialization State	Null/Inactive State
	Reconnect State	(Dormant State)
MS Control on the Traffic Channel State	Connected State	Active/Connected State

The energy consumption could be categorized into three levels. The *MS control on the traffic channel state* consumes the most energy. The *system access state* consumes energy at a medium level. The *MS idle state* consumes the least energy. The classification is basically the same as that in 3GPP. Similar to the states of CELL\_PCH and URA\_PCH in 3GPP, which can utilize the DRX mode, the state of *MS idle* in 3GPP2 can also employ a session-related technique called the slotted mode [21]. Both the slotted mode and the DRX mode allow the MS to monitor only certain slots instead of continuously monitoring the paging channel. In contrast to 3GPP in which the network only retains the PS signaling connection in the *sleep mode*, the PDSN and the PCF in 3GPP2 preserve the PPP session and the A10 connection for users to realize the *always on* functionality. By preserving these resources, the impact of energy conservation on reconnection cost could be minimized. The only cost is the latency of establishing the radio connection and the A8 connection.

#### IV. QUALITATIVE COMPARISON

This section presents qualitative comparison of energy-saving techniques that are developed in 3GPP and 3GPP2. The qualitative comparison is elaborated by using examples of the signaling and data flows of 3GPP and 3GPP2.

3GPP and 3GPP2 differ much from the packet data architecture of each other. However, concepts of energy conservation of both systems are similar in certain extent. The 3GPP2 upper layer signaling in Fig. 10 is more complicated than the 3GPP RRC in Fig. 3. RRC is specifically designed for RN-related signaling and control tasks. However, the upper layer signaling is in charge of all upper layers (OSI layers 3–7), as well as the physical layer signaling services. MSL3P could be viewed as the counterpart of RRC from the perspective of energy conservation. Both the states of MSL3P and RRC represent the type and the direction of the radio channel possessed by the MS/UE. They also stand for the status of energy saving, i.e., whether the MS/UE can enter the sleep mode or not. Although MSL3P in 3GPP2 could be regarded as the corresponding counterpart of RRC in 3GPP, it does not monitor the activity of the packet data service as RRC does. Instead, MSL3P delegates this job to the PDSCC state machine. This is because the state transition between the *system access state* and the *MS control on the traffic channel state* in MSL3P is unidirectional. Consequently, the activity of the packet data service must be supervised by the PDSCC state machine.

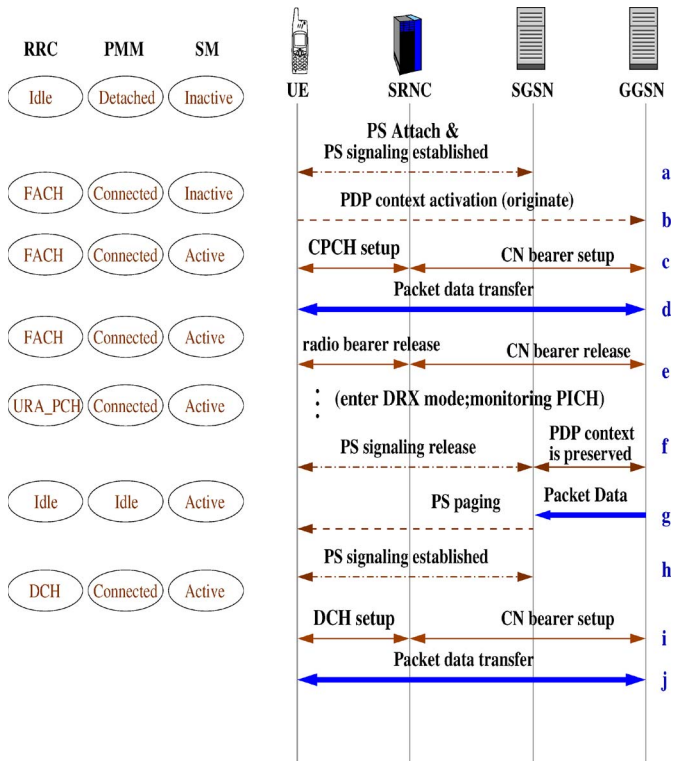

Fig. 12. Example flows and the corresponding states in 3GPP.

The PDSCC state machine in 3GPP2 manages the *packet zone* reconnection, whereas the PMM state machine in 3GPP handles the RA update. Both of them speed up the process of reconnection. However, the PDSCC state machine is more complicated than the PMM state machine because the PDSCC state machine governs the radio parameter configuration and QoS setting as well. The PDS state machine and the SM state machine monitor the status of packet sessions. Nevertheless, the PDS state machine has one more state than the SM state machine, i.e., the *dormant state*. One can also find the RRC functional model in 3GPP2’s RAN. However, it does not have the similar state model in 3GPP.

Figs. 12 and 13 illustrate the relationship between the state machines in 3GPP and 3GPP2 in packet data sessions. Flow a to flow j in Fig. 12 are analogous to flow a to flow j in Fig. 13. Initially, the MS/UE sets up the packet connection and then transfers the packets to the network. After flow d in both Figs. 12 and 13, there is no data transmission for a short period. The MS/UE, thus, enables the sleep mode (or the dormant mode) and releases some resources. Afterward, when the network has data that are destined to the MS/UE, the network tries to page the MS/UE by flow g in Fig. 12 and flow f in Fig. 13. When the MS/UE receives the paging message, it reestablishes the connection to the network and starts to receive packets.

Fig. 12 illustrates how SM, PMM, and RRC change their states during the exemplary packet data flows in the right side of the figure. This example is based on Web browsing, one of the most common packet data applications. The example utilizes the common channel and the dedicated channel to separately transfer packet data according to different QoS re-

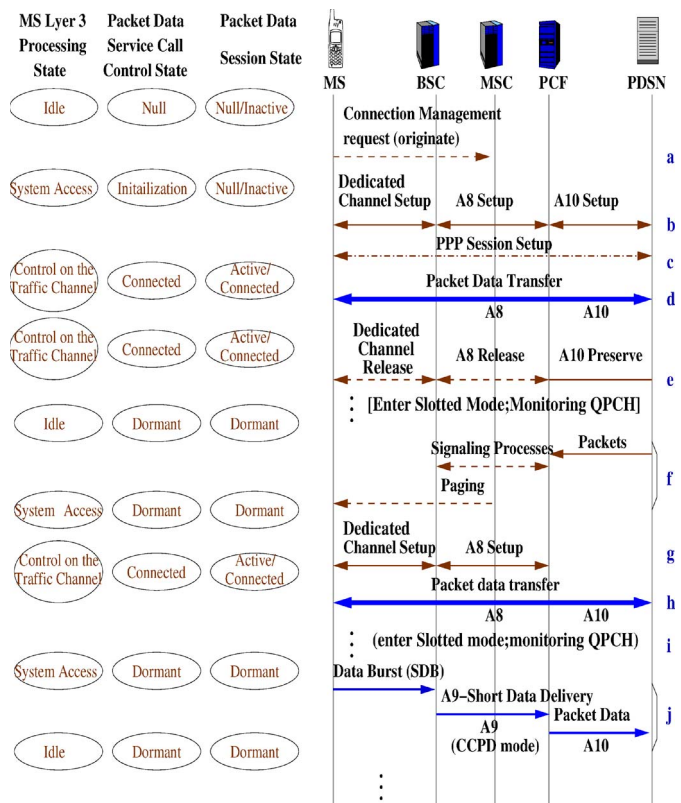

Fig. 13. Example flows and the corresponding states in 3GPP2.

quirements. It should be mentioned that the inactive state of SM in flow b is a transient state that will change to the active state very soon. In the figure, flow e that may be caused by the expiration of the inactivity timer indicates the RRC state transition (resource-related) for releasing the CPCH and other uplink channels. After flow e, the UE operates in the DRX mode (session-related) and monitors the PICH [14], which allows the UE to conserve more energy than the traditional paging channel. If the idle period lasts for a long time, the network may consider that the data transfer is possibly quite small. The network should relinquish the PS signaling but still preserve the PDP context. The *always on* technique in 3GPP is realized by maintaining the PS signaling and the PDP context. For instance, if the PS signaling is still active, the UE can begin the data transfer in flow i. Otherwise, the UE must perform flow h first. Note that the SGSN is responsible for originating the paging request in the PS domain.

Fig. 13 shows how PDS, PDSCC, and MSL3P change their states in the exemplary packet data flows. Flow b employs the dedicated channel because the dedicated packet channel (dpch) belongs to the dedicated channel. Flow e may be caused by the expiration of the *packet data inactivity timer* maintained by the MS in the *connected state* of PDSCC. Similar to 3GPP, the transition of MSL3P from the *MS control on the traffic channel state* to the *MS idle state* causes the release of the dedicated channel (dpch). However, not all of the connections that are established in the CN are released. The *always on* technique in 3GPP2 preserves the A10 connection and the PPP session for the MS. Similar to the 3GPP DRX mode, the MS may operate in the *slotted mode* in 3GPP2. Also, the MS could monitor

TABLE V  
SUMMARY OF COMPARATIVE COMPARISON

	3GPP	3GPP2
Resource-related energy saving scheme	inactivity timer (combined with traffic volume measurement) of RRC states	inactivity timer of PDSCC state
State-related energy saving scheme (optional)	DRX mode and PICH	Slotted mode and QPCH
Always on techniques	By maintaining PS signaling connection and PDP context	By preserving PPP session (with dormant hand-off) and A10 connection
Packet data on common channel	through common or share channel (e.g. CPCH)	through CCPD mode combined with SDB
Session management	SM state machine	PDS state machine
Activity management	PMM and RRC state machines	PDSCC state machine and PDS state machine
Resource control	RRC state machine	MSL3P state machine
Timer function	From the CELL_PCH state to the URA_PCH state (CELL_DCH to CELL_FACH; CELL_FACH to CELL_PCH)	From Connected state to Dormant state and from Dormant state to Connected state

the quick paging channel [21], which is similar to the PICH in 3GPP, to enhance the efficiency of energy saving. *Flow h* to *flow l* show an example of packet call termination when the PDSN sends packet data, which are actually destined to a dormant MS, to the PCF. Once the PCF receives the data, it will notify the BSC to request the paging service from the MSC. After that, the MSC (which will be the SGSN in 3GPP) issues the paging request. *Flow j* gives an example of the CCPD mode operation with SDB, in which the MS does not need to *wake up* completely. It only changes its MSL3P state to the *system access state* and requests for a common channel for transmission using SDB. The PDS and PDSCC state machines stay in the *dormant state* in this case. In *flow j*, the MS avoids the cost of establishing an A10 connection and the signaling overhead to establish an A8 connection by delivering SDBs through the A9 connection in the CCPD mode.

The above comparisons demonstrate the *energy-saving* procedures and associated processes of session management for *always on* during packet data communication in WCDMA and cdma2000 systems. We highlight the necessity of session management techniques, which compensate the reconnection overhead that is caused by the enhancement of resource and energy efficiency. Table V summarizes the comparative study.

## V. QUANTITATIVE COMPARISON

Various factors affect the energy consumption in 3G systems. We observe that the state machines, the inactivity timers, and the traffic models are three major elements that determine the energy consumption for packet data services in WCDMA and cdma2000. Different states in the UE/MS determine the type of radio resources that the UE/MS may possess. The state may also imply the overhead such as registration and update delays. The inactivity timers of the state machines control the state transitions. Once the UE/MS is idle for a certain time, the associated timer would be expired. The UE/MS then transits from one state to another. Hence, the energy consumption of each state could be evaluated. Furthermore, user behavior and user traffic essentially dominate energy consumption. User

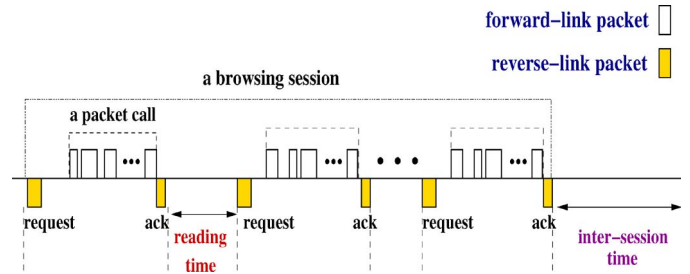

Fig. 14. Web browsing traffic model.

behavior affects the duration that the UE/MS will stay in a state. User traffic governs the channel resources that the UE/MS may be allocated.

In this section, we aim to quantify the performance of energy consumption in 3GPP/WCDMA and 3GPP2/cdma2000. Traffic models and the corresponding analytic model are constructed. Moreover, the impact of the inactivity timer on energy consumption and reconnection cost is studied.

### A. Traffic Models

In this paper, traffic models are categorized into nonreal-time traffic and real-time traffic. We use Web browsing for nonreal-time traffic and streaming video for real-time traffic. The reason is that they are two major high-speed packet data services. Compared with other traffic types, in addition, they usually consume more energy. Energy conservation is more important in Web browsing and streaming video.

1) *Nonreal-Time Traffic Model—Web Browsing*: The traffic model of the Web browsing we use is suggested by 3GPP in [25] and 3GPP2 in [26]. As depicted in Fig. 14, a typical traffic model (forward and reverse links) of Web browsing consists of several browsing sessions. Packet arrivals in the reverse link comprise *request* and *acknowledgment (ack)*. Each session in the forward link includes one or several *packet calls* that contain a sequence of packets. The duration between two packet calls is called the *reading time*. Furthermore, the period between two sessions is called the *intersession time*. We can see that the

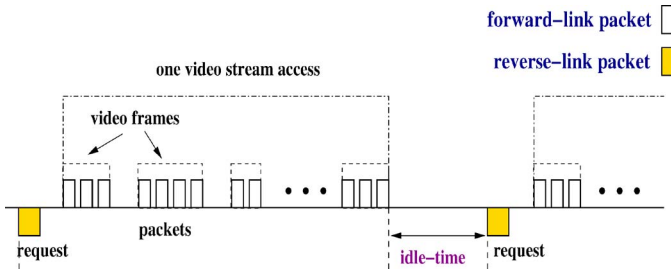

Fig. 15. Video streaming traffic model.

length of a Web browsing session is implicitly modeled by the number of packet calls. Moreover, the length of a packet call is implicitly determined by each packet size and the number of packets. The parameters we use are also based on the suggestion from standards [25]. They are itemized as follows:

- *session arrival process*. the time between two successive sessions is modeled as a geometrically distributed random variable (RV) (discrete analog of an exponential distribution) with a mean value of 600 s. The number of session arrivals is also a geometric RV;
- *number of packet calls per session*. a geometric RV with a mean of five packet calls;
- *reading time between two consecutive packet calls in a session*. a geometric RV with a mean of 412 s;
- *number of packets in a packet call*. a geometric RV with a mean of 25 packets;
- *time interval between two consecutive packets inside a packet call*. a geometric RV with a mean of 0.0625 s;
- *packet size*. Pareto distribution with a cutoff is used. The value of the scale parameter is 81.5, and the value of the shape parameter is 1.1. Therefore, the average packet size is 480 bytes.

2) *Real-Time Traffic Model—Streaming Video*: To be more realistic, we use the video traces from [27] as the video source. The traces are collections of several H.263 videos with a target rate of 64 kb/s. There are ten video clips. Each one is around 60 min long. To model the traffic from a video server, each time, we randomly choose one video trace. Video frames are sequentially sent to the UE/MS. The packet size is limited by 1500 bytes, which is the *maximum transmission unit* of the IP. Once the video is transmitted completely, we randomly choose one and continue the same process again.

The user behavior is modeled as an ON-OFF model. A user accesses the video during the ON period. The number of packets that are received is determined by the video server by which video is sending now. During the OFF period, which is also called the idle time, there is no video access. Therefore, there is no video traffic in the OFF period. Thus, there are two statistic parameters—the duration of ON time and the duration of OFF time. The mean values are listed as follows [25]:

- *access time of a streaming video (ON time)*. an exponential RV with a mean of 30 s;
- *idle time between two successive streaming video accesses (OFF time)*. an exponential RV with a mean of 120 s.

Fig. 15 illustrates the video traffic model for forward and reverse links.

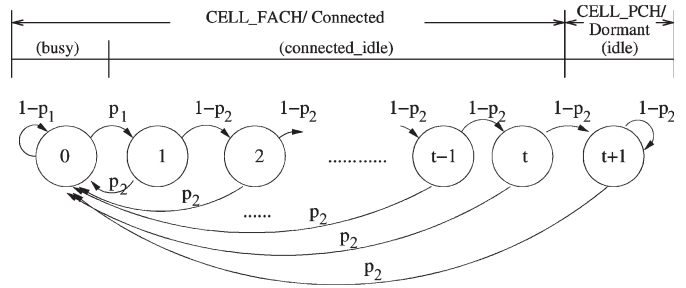

Fig. 16. Discrete time Markov chain for one inactivity timer.

### B. Analytic Model

This section analyzes the state transition behavior for real-time and nonreal-time traffic in WCDMA and cdma2000. The expected *energy consumption* and *reconnection cost* in communication sessions are evaluated. The term *reconnection* is defined as that the UE/MS requests the packet data service again in the same session, but the capability of its current state cannot support this request, that is, state transition is necessary. Reconnection may waste additional time and resource to renegotiate the channel resources. Although shortening the timer length may conserve the energy of the UE/MS, the probability of reconnection will also increase. It is a tradeoff between saving energy and reducing reconnection probability. Therefore, the parameters should be configured carefully.

For WCDMA, we assume that the resource of the CELL\_FACH state is capable for the UE to access nonreal-time traffic. Furthermore, the UE should transit to the CELL\_DCH state to access real-time traffic. For cdma2000, on the other hand, an MS transits to the connected state to access nonreal-time and real-time traffic. Note that, to model the discrete timer behavior, nonreal-time traffic and real-time traffic are modeled by a discrete-time Markov chain. We transform the real-time traffic modeling from a continuous model to a discrete-time model. In other words, the mean durations of the access time and the idle time are modeled by a geometric RV that is the discrete analog of the exponential RV.

The discrete-time Markov chain in Fig. 16 models the state transition behavior, which merely involves one single inactivity timer. That is, it can be used to model the nonreal-time traffic in WCDMA and cdma2000 and the real-time traffic in cdma2000. State 0 represents that the channel is busy, and the UE/MS stays in the CELL\_FACH state. States 1 to  $t$  represent that the channel is temporarily idle, and the inactivity timer of CELL\_FACH is counting. We define this as *connected-idle* states. State  $t + 1$  represents that the inactivity timer has expired, and the UE/MS has transited to the CELL\_PCH or dormant state.

Accessing the real-time traffic in WCDMA generally engages two inactivity timers because the UE stays in the CELL\_DCH state when accessing the real-time traffic. The Markov chain is illustrated in Fig. 17. In the Markov chain, state 0 represents that the channel is busy, and the UE is in the CELL\_DCH state. States 1 to  $t_1$  stand for the fact that the first inactivity timer of CELL\_DCH is counting. After the first timer expires, the second inactivity timer of CELL\_FACH starts counting from state  $t_1 + 1$  to state  $t_1 + t_2$ . State  $t_1 + t_2 + 1$

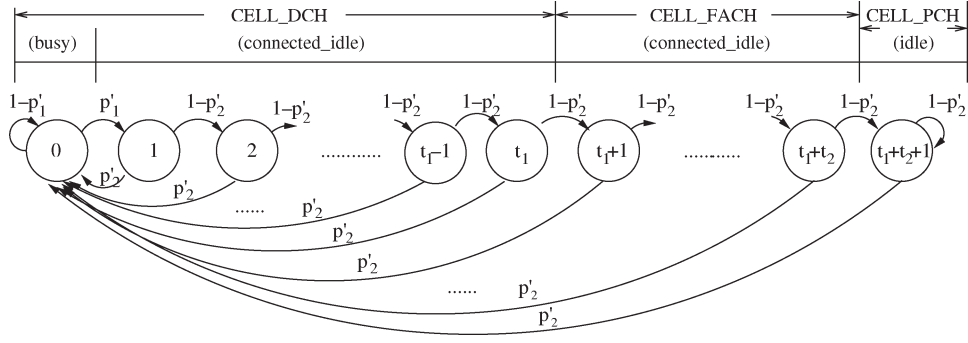

Fig. 17. Discrete-time Markov chain for two inactivity timers.

represents that the second inactivity timer has also expired, and the UE has transmitted to the CELL\_PCH state.

In Fig. 16, let  $p_1$  denote the probability that the *packet call* is finished. Let  $p_2$  denote the probability that the reading time terminates. We derive the following transition probability matrix:

$$P = \begin{bmatrix} 1-p_1 & p_1 & 0 & \cdots & 0 & 0 \\ p_2 & 0 & 1-p_2 & \cdots & 0 & 0 \\ p_2 & 0 & 0 & \ddots & 0 & 0 \\ \vdots & \vdots & \vdots & \ddots & \ddots & \vdots \\ p_2 & 0 & \cdots & \ddots & 1-p_2 & 0 \\ p_2 & 0 & \cdots & \cdots & 0 & 1-p_2 \\ p_2 & 0 & \cdots & \cdots & 0 & 1-p_2 \end{bmatrix}. \quad (1)$$

Let  $\pi = [\pi_0, \pi_1, \dots, \pi_t, \pi_{t+1}]$  be the *steady-state* probabilities of the Markov chain. By solving  $\pi = \pi P$  and  $\pi e = 1$ , where  $e$  is a column vector with all elements equal to 1, we get

$$\pi_i = \begin{cases} \frac{p_2}{p_1+p_2}, & (i=0) \\ \frac{p_1 p_2 (1-p_2)^{i-1}}{p_1+p_2}, & (1 \leq i \leq t) \\ \frac{p_1 (1-p_2)^t}{p_1+p_2}, & (i=t+1). \end{cases} \quad (2a)$$

$$\pi_i = \begin{cases} \frac{p_2}{p_1+p_2}, & (i=0) \\ \frac{p_1 p_2 (1-p_2)^{i-1}}{p_1+p_2}, & (1 \leq i \leq t) \\ \frac{p_1 (1-p_2)^t}{p_1+p_2}, & (i=t+1). \end{cases} \quad (2b)$$

$$\pi_i = \begin{cases} \frac{p_2}{p_1+p_2}, & (i=0) \\ \frac{p_1 p_2 (1-p_2)^{i-1}}{p_1+p_2}, & (1 \leq i \leq t) \\ \frac{p_1 (1-p_2)^t}{p_1+p_2}, & (i=t+1). \end{cases} \quad (2c)$$

Similarly, in Fig. 17, let  $p'_1$  denote the probability that the video session terminates. Let  $p'_2$  denote the probability that the idle time terminates. Thus, we obtain the steady-state probability of the Markov chain, i.e.,

$$\pi'_i = \begin{cases} \frac{p'_2}{p'_1+p'_2}, & (i=0) \\ \frac{p'_1 p'_2 (1-p'_2)^{i-1}}{p'_1+p'_2}, & (1 \leq i \leq t_1+t_2) \\ \frac{p'_1 (1-p'_2)^{t_1+t_2}}{p'_1+p'_2}, & (i=t_1+t_2+1). \end{cases} \quad (3a)$$

$$\pi'_i = \begin{cases} \frac{p'_2}{p'_1+p'_2}, & (i=0) \\ \frac{p'_1 p'_2 (1-p'_2)^{i-1}}{p'_1+p'_2}, & (1 \leq i \leq t_1+t_2) \\ \frac{p'_1 (1-p'_2)^{t_1+t_2}}{p'_1+p'_2}, & (i=t_1+t_2+1). \end{cases} \quad (3b)$$

$$\pi'_i = \begin{cases} \frac{p'_2}{p'_1+p'_2}, & (i=0) \\ \frac{p'_1 p'_2 (1-p'_2)^{i-1}}{p'_1+p'_2}, & (1 \leq i \leq t_1+t_2) \\ \frac{p'_1 (1-p'_2)^{t_1+t_2}}{p'_1+p'_2}, & (i=t_1+t_2+1). \end{cases} \quad (3c)$$

Assume that the average power consumption in *busy*, *connected idle*, and *idle* in Fig. 16 is given by  $W_b$ ,  $W_{ci}$ , and  $W_i$ , respectively. Furthermore, the mean power consumption of *busy*, *connected-idle in CELL\_DCH*, *connected-idle in CELL\_FACH*, and *idle* in Fig. 17 is given by  $W_{dch}$ ,  $W_{t1}$ ,  $W_{t2}$ , and  $W_{pch}$ , respectively. Assuming that the session length is  $T_s$ , we can calculate the expected energy consumption  $E[Es]$  in the *downlink/upward link* of the nonreal-time traffic in

WCDMA and the real-time/nonreal-time traffic in cdma2000 during the communication session as follows:

$$\begin{aligned} E[Es] &= \left( W_b \cdot \pi_0 + W_{ci} \cdot \sum_{i=1}^t \pi_i + W_i \cdot \pi_t \right) \cdot T_s \\ &= [p_2 W_b + p_1 (1 - (1-p_2)^t) W_{ci} + (1-p_2)^t p_1 W_i] \\ &\quad \cdot T_s / (p_1 + p_2). \end{aligned} \quad (4)$$

The expected energy of the real-time traffic in WCDMA, i.e.,  $E[Es']$ , is given by

$$\begin{aligned} E[Es'] &= \left( W_{dch} \cdot \pi'_0 + W_{t1} \cdot \sum_{i=1}^{t_1} \pi'_i + W_{t2} \right. \\ &\quad \left. \cdot \sum_{i=t_1+1}^{t_1+t_2} \pi'_i + W_{pch} \cdot \pi'_{t_1+t_2+1} \right) \cdot T_s \\ &= [p'_2 W_{dch} + p'_1 (1 - (1-p'_2)^{t_1}) W_{t1} \\ &\quad + p'_1 (1-p'_2)^{t_1} (1 - (1-p'_2)^{t_2}) W_{t2} \\ &\quad + p'_1 (1-p'_2)^{t_1+t_2} W_{pch}] \cdot T_s / (p'_1 + p'_2). \end{aligned} \quad (5)$$

Based on the steady-state probability, the expected number of reconnections  $E[Nr_i]$  of the nonreal-time traffic in WCDMA and the real-time/nonreal-time traffic in cdma2000 is derived as

$$E[Nr_i] = \frac{p_1 p_2 (1-p_2)^t}{p_1 + p_2} \cdot T_s. \quad (6)$$

Likewise, the expected number of reconnections from the CELL\_FACH state, i.e.,  $E[Nr'_f]$ , for the real-time traffic in WCDMA is given by

$$\begin{aligned} E[Nr'_f] &= \sum_{i=t_1+1}^{t_1+t_2} \frac{p'_1 p'_2 (1-p'_2)^{i-1}}{p'_1 + p'_2} \cdot T_s \\ &= \frac{p'_1 p'_2 (1-p'_2)^{t_1} (1 - (1-p'_2)^{t_2})}{(p'_1 + p'_2)} \cdot T_s. \end{aligned} \quad (7)$$

Also, the expected number of reconnections from the CELL\_PCH state, i.e.,  $E[Nr'_p]$ , for the real-time traffic in WCDMA is given by

$$E[Nr'_p] = \frac{p'_1 p'_2 (1 - p'_2)^{t_1 + t_2}}{p'_1 + p'_2} \cdot T_s. \quad (8)$$

As mentioned above, the proper choice of the inactivity timers should consider energy consumption and reconnection cost. Let  $C_i$  denote the cost of each reconnection from the *idle* state in Fig. 16. Therefore, for the nonreal-time traffic in WCDMA and the real-time/nonreal-time traffic in cdma2000, the proper timer length could be calculated by solving

$$E[Nr_i] \cdot C_i = E[EG_s]. \quad (9)$$

The proper timer length  $t$  is then calculated as

$$t = \frac{\ln(p_2 W_b + p_1 W_{ci}) - \ln(p_1 p_2 C_i + p_1 W_{ci} - p_1 W_i)}{\ln(1 - p_2)}. \quad (10)$$

For the real-time traffic in WCDMA, let the reconnection cost from the CELL\_FACH state and the CELL\_PCH state to the CELL\_DCH state be  $C_f$  and  $C_p$ , respectively. The relation of the two timer lengths can be derived from the following:

$$E[Nr'_f] \cdot C_f + E[Nr'_p] \cdot C_p = E[EG'_s]. \quad (11)$$

It is further derived as

$$t_1 = \left[ \ln(p'_2 W_d + p'_1 W_{t_1}) - \ln \left( p'_1 \left( p'_2 C_f + p'_2 (1 - p'_2)^{t_2} (C_p - C_f) + (W_{t_1} - W_{t_2}) + (1 - p'_2)^{t_2} (W_{t_2} - W_p) \right) \right) \right] / \ln(1 - p'_2). \quad (12)$$

### C. System Parameters Varied

To quantify the analysis above for energy consumption, we still need to know the power required for packet transmission and reception. The power in this paper is based on [24] and [28]. The total power required in the *uplink/reverse link* could be approximated by the following:

$$P_{UL} = P_{Txhw} + P_p \quad (13)$$

where  $P_{Txhw}$  is the mean power for transmitting data in the physical layer.  $P_{Txhw}$  is derived as

$$P_{Txhw} = r P_{radiated} + P_{Txfix}. \quad (14)$$

Also,  $P_p$  in (13) is the power required for protocol-related activities for supporting the data transmission in the uplink. In addition,  $P_{radiated}$  in (14) is the actual radiated transmission power, and  $r$  is a proportionality factor [24], [28]. Furthermore,  $P_{Txfix}$  is the power required by amplifier-unrelated parts, e.g., baseband.

Similarly, the total power required for downlink/forward link is approximated as follows:

$$P_{DL} = P_{Rxhw} + P_p \quad (15)$$

where  $P_{Rxhw}$  is the power to process the received data in the physical layer.  $P_p$  is the power required for protocol-related activities for supporting the data reception in the downlink.

The mean power consumption of each state is enumerated as follows:

- $E[P_{UL}]$ . mean power consumption in the uplink/reverse link for packet transmission: 0.25 W;
- $E[P_{DL}]$ . mean power consumption in the downlink/forward link for packet reception (when the UE of 3GPP is in the CELL\_DCH state or the MS of 3GPP2 is in the MS control on the traffic channel state): the value is assumed to be 0.1 W for Web browsing and 0.15 W for video streaming;
- $E[P_{c-idle}]$ . mean power consumption when the UE is in the CELL\_DCH or CELL\_FACH state or the MS is in the MS control on the traffic channel state, but there is no packet transmission and reception (this is called “connected-idle”); the value is assumed to be 0.08 W for Web browsing (in this case, the UE is in the CELL\_FACH state, or the MS is in the MS control on the traffic channel state) and 0.12 W for video streaming (in this case, the UE is in the CELL\_DCH state, or the MS is in the MS control on the traffic channel state);
- $E[P_{idle}]$ . mean power consumption in the sleep/dormant mode and when the UE is in the CELL\_PCH or URA\_PCH state or the MS is in the MS idle state: the value is assumed to be 0.01 W for monitoring the paging message and updating the RA in 3GPP or the packet zone in 3GPP2.

## VI. NUMERICAL RESULTS

This section presents the numerical results of the analysis developed in Section V. The analysis is validated by extensive simulations using *Network Simulator—version 2 (ns-2)*. We adopt the nonreal-time and real-time traffic models described in Section V-A as the traffic sources. The energy consumption is calculated following the parameters presented in Section V-C.

Fig. 18(a) and (b) illustrates the energy consumption of the real-time traffic in cdma2000 and WCDMA, respectively. The figure shows the cumulated energy consumption when time increases with different inactivity timers. The mean energy at a different state is defined in Section V-C. Also, based on Section V-A, the mean access time is 30 s, and the mean idle time is 120 s. To make Fig. 18(a) and (b) comparable, the total length of the two inactivity timers in Fig. 18(b) is identical to the length of the inactivity timer in Fig. 18(a). Moreover, the two inactivity timers in Fig. 18(b) are configured to be the same value. For instance, if the length of the inactivity timer in Fig. 18(a) is 40 s, the values of the two inactivity timers in Fig. 18(b) are both 20 s.

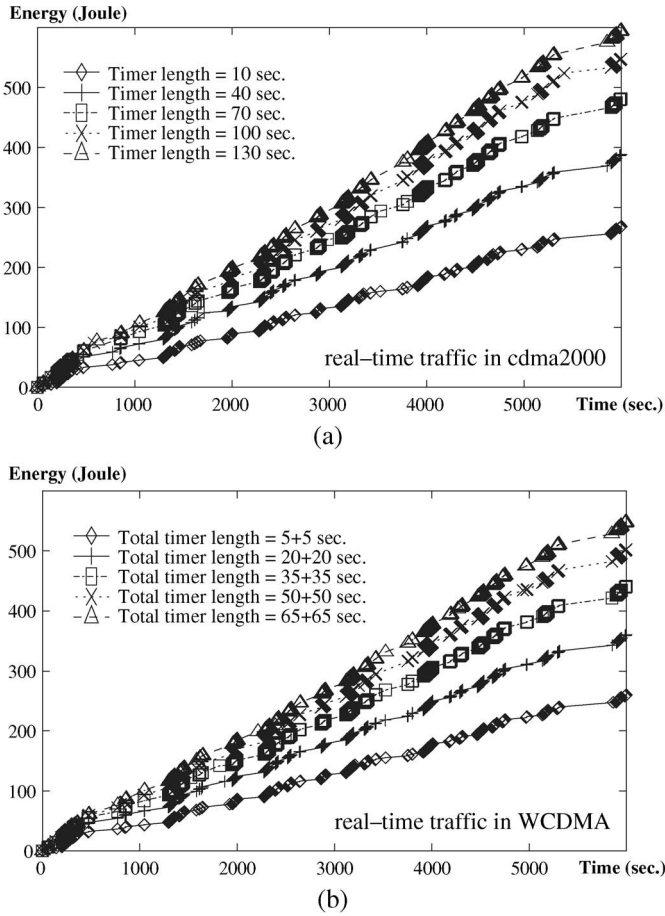

Fig. 18. (a) Energy consumption for the real-time traffic in cdma2000 with different lengths of timers: 10, 40, 70, 100, and 130. (b) Energy consumption for the real-time traffic in WCDMA with different lengths of timers: 10, 40, 70, 100, and 130.

As indicated in Fig. 18, the total energy consumption of the UE in WCDMA is less than that of an MS in cdma2000 with the same timer length. This is because there are two levels of energy consumption (CELL\_DCH and CELL\_FACH) before the UE in WCDMA enters the sleep mode, whereas there is only a single level of energy consumption before the MS in cdma2000 becomes dormant. Thus, the UE consumes less energy.

The energy consumption and the number of reconnections experienced in a session are further compared in Figs. 19 and 20. In the figures, the simulation time  $T_s$  is set to 5000 s. The  $x$ -axis, which represents the total timer length, is set from 10 to 120 s. Note that, for the real-time traffic in WCDMA, we let the two timer lengths be half of the timer length of cdma2000. Therefore, the sum of the two timers in WCDMA is equal to the timer length of cdma2000. That is, the point of 20 means that both timers in WCDMA are configured as 10 s. The lines are the results that are derived from the analytic models in Figs. 16 and 17. Moreover, the simulation results are presented by the points. Based on Section V-A, for nonreal-time traffic, the average durations of a packet call and a reading time are 3 and 412 s, respectively. Thus,  $p_1$  and  $p_2$  are set as  $1/3$  and  $1/412$ , respectively. Similarly, for real-time traffic, the mean access time and the mean idle time are 30 and 120 s, respectively. Thus,  $p'_1$  and  $p'_2$  are set as  $1/30$  and  $1/120$ , respectively. Consequently,

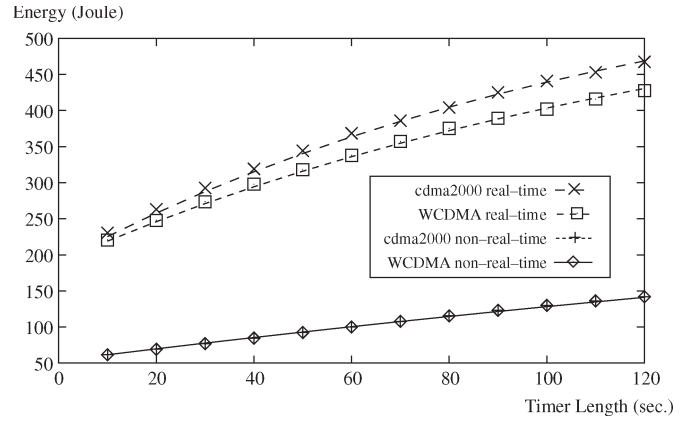

Fig. 19. Comparison for energy consumption.

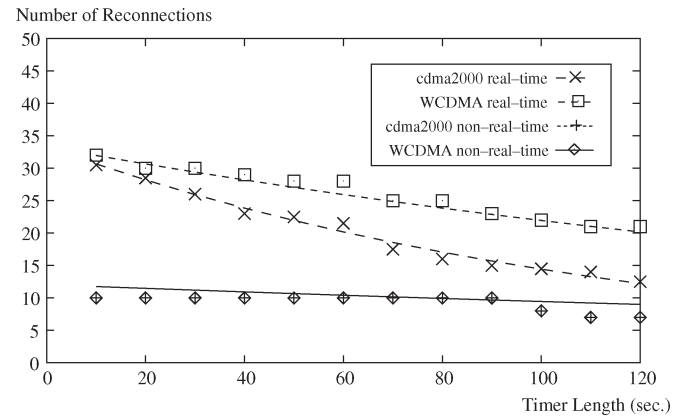

Fig. 20. Comparison for number of reconnections.

the accuracy of the proposed analytic models in Figs. 16 and 17 is validated.

Fig. 19 indicates that when the timer length increases, the energy consumption increases as well. Fig. 20, on the contrary, indicates that the number of reconnections experienced in the session reduces when the timer length increases. It is observed that the design of two timers for accessing the real-time traffic in WCDMA conserves more energy. However, the UE experiences more reconnections during the session because it releases the dedicated channel when the first timer expires. Moreover, more state transitions also imply more complicated resource management. It is a tradeoff between energy conservation and reconnection cost.

In Figs. 21–23, we present examples for optimizing the timer length. Because WCDMA mainly involves two inactivity timers when accessing real-time traffic, we first use nonreal-time traffic to evaluate the timer length for the CELL\_FACH. In Fig. 21, the reconnection cost  $C_i$  is set to 6. As shown in the figure, the lines of energy consumption and reconnection cost intersect when the timer length is around 20. In fact, based on (10), the optimal timer length is 19.01. Therefore, we could claim that the optimal timer length is 19 s if the cost  $C_i$  is set to 6.

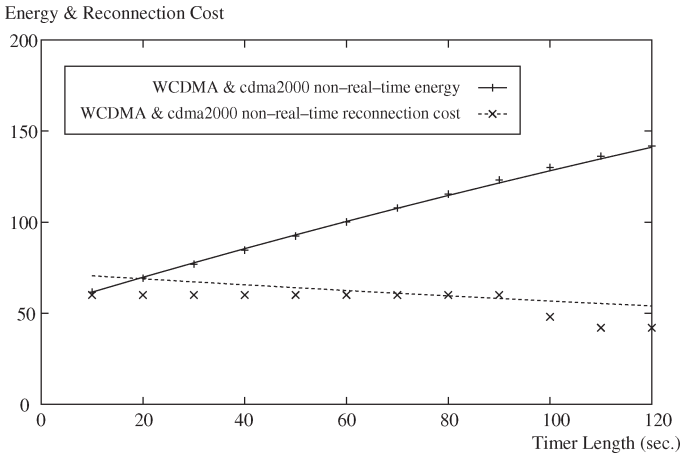

Fig. 21. Optimizing timer for nonreal-time traffic.

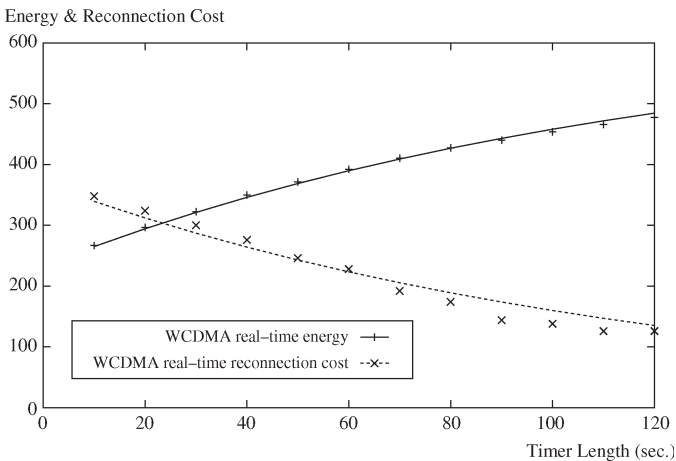

Fig. 22. Optimizing timer for the real-time traffic in WCDMA.

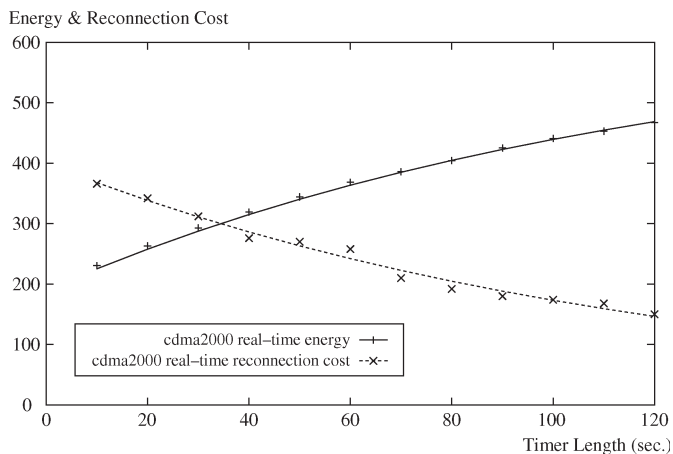

Fig. 23. Optimizing timer for the real-time traffic in cdma2000.

Next, we fix the timer of the CELL\_FACH state to 20 and intend to find the optimal timer length for the CELL\_DCH state. In Fig. 22, the two reconnection costs  $C_f$  and  $C_p$  are set to 6 and 12, respectively, because we assume that reconnecting from CELL\_PCH costs double of reconnecting from CELL\_FACH. Thus, as shown in Fig. 22, the optimal timer

length for the CELL\_DCH state is still around 20 s. Based on (12), the optimal timer length is 23.36 s.

For cdma2000, Fig. 21 is still applicable for nonreal-time traffic. However, the behavior of accessing real-time traffic is different from that of accessing nonreal-time traffic. The timer length needs to be reconsidered. In Fig. 23, we assume that the reconnection cost  $C_i$  is 12, which corresponds with  $C_p$  for the CELL\_PCH state. Therefore, the optimal timer length is around 34 s, as shown in the figure. Based on (10), the optimal value is 34.38 s.

Based on the analysis above, operators could choose suitable timer lengths that conserve energy and reduce reconnection cost. Operators may also adopt a more flexible dynamic timer length mechanism to dynamically adjust the reconnection cost.

## VII. CONCLUSION AND FUTURE WORK

This paper presents the energy-conservation techniques in 3GPP and 3GPP2. Qualitative comparison has been provided to demonstrate the energy-saving procedures and the associated SM for *always on* techniques in WCDMA and cdma2000 systems. In addition, we have developed analytic models to investigate the energy consumption and the reconnection cost in WCDMA and cdma2000. Based on the models, this paper also quantifies the performance. Extensive simulations have been performed to validate the analytic models. We have observed that the two-level state transition for accessing the real-time traffic in WCDMA may conserve more energy. It, however, experiences more reconnections than that in cdma2000. Therefore, it is crucial to carefully configure the parameters. Based on our analysis, operators can choose suitable parameters that balance energy conservation and reconnection cost. In addition to providing insights of the energy-conservation mechanisms of 3GPP and 3GPP2, which are often difficult to directly obtain from standards specifications, results that have been shown in this paper are also practical for 3GPP and 3GPP2 operators to determine proper parameters.

There are some possible extensions for this paper. Although 3G packet-switched services are expected to conserve more energy than that in 2G circuit-switched services, there are enhancements in energy efficiency for 3G technologies in both hardware and algorithms. Comparison of energy efficiency for 2G and 3G systems is a potential future research. Furthermore, the techniques that have been developed in this paper can be the basis for the comparison of the energy-conservation techniques discussed in 3GPP Long Term Evolution (LTE) [29] and 3GPP2 Air Interface Evolution (AIE) [30]. Choosing the parameters of the energy-saving technologies in 3GPP LTE and 3GPP2 AIE needs more investigation.

## REFERENCES

- [1] R. Kohno, R. Meidan, and L. B. Milstein, "Spread spectrum access methods for wireless communications," *IEEE Commun. Mag.*, vol. 33, no. 1, pp. 58–67, Jan. 1995.
- [2] C. E. Jones, K. M. Sivalingam, P. Agrawal, and J.-C. Chen, "A survey of energy efficient network protocols for wireless networks," *Wireless Netw.*, vol. 7, no. 4, pp. 343–358, Jul. 2001.
- [3] S.-R. Yang and Y.-B. Lin, "Performance analysis of UMTS power saving mechanism," in *Proc. NCS*, Taichung, Taiwan, Dec. 2003.



- [4] J.-H. Yeh, C.-C. Lee, and J.-C. Chen, "Performance analysis of energy consumption in 3GPP networks," in *Proc. IEEE WTS*, Pomona, CA, May 2004, pp. 67–72.
- [5] S.-R. Yang and Y.-B. Lin, "Modeling UMTS discontinuous reception mechanism," *IEEE Trans. Wireless Commun.*, vol. 4, no. 1, pp. 312–319, Jan. 2005.
- [6] C.-C. Lee, J.-H. Yeh, and J.-C. Chen, "Energy efficiency in cdma2000 high-speed packet data services," in *Proc. ICWN*, Las Vegas, NV, Jun. 2003, pp. 328–334.
- [7] C.-C. Lee, J.-H. Yeh, and J.-C. Chen, "Impact of inactivity timer on energy consumption in WCDMA and cdma2000," in *Proc. IEEE WTS*, Pomona, CA, May 2004, pp. 15–24.
- [8] *General Packet Radio Service (GPRS) Service Description; Stage 2*, Jun. 2006. 3GPP Spec., Rel. 6, TS 23.060 v6.13.0.
- [9] *Radio Resource Control (RRC) Protocol Specification*, Jun. 2006. 3GPP Spec., Rel. 6, TS 25.331 v6.10.0.
- [10] *Architecture Requirements*, Jun. 2004. 3GPP Spec., Rel. 6, TS 23.221 v6.3.0.
- [11] J.-C. Chen and T. Zhang, *IP-Based Next-Generation Wireless Networks*. Hoboken, NJ: Wiley, Jan. 2004. [Online]. Available: <http://www.cs.nthu.edu.tw/~jcchen/book.html>
- [12] *Spreading and Modulation (FDD)*, Mar. 2006. 3GPP Spec., Rel. 6, TS 25.213 v6.5.0.
- [13] *Radio Interface Protocol Architecture*, Oct. 2005. 3GPP Spec., Rel. 6, TS 25.301 v6.4.0.
- [14] *Physical Channels and Mapping of Transport Channels Onto Physical Channels (FDD)*, Dec. 2005. 3GPP Spec., Rel. 6, TS 25.211 v6.7.0.
- [15] *Mobile Radio Interface Layer 3 Specification; Core Network Protocols; Stage 3*, Jun. 2006. 3GPP Spec., Rel. 6, TS 24.008 v6.13.0.
- [16] K. Parsa, "Common packet channel (CPCH): The optimum wireless Internet mechanism in W-CDMA," in *Proc. Int. Conf. 3G Mobile Commun. Technol.*, London, U.K., Mar. 2000, pp. 148–155.
- [17] H. Holma and A. Toskala, *WCDMA for UMTS*. Hoboken, NJ: Wiley, 2001.
- [18] *UTRAN Iur interface RNSAP signalling*, Jan. 2005. 3GPP Spec., Rel. 6, TS 25.423 v6.4.0.
- [19] C. Perkins, *IP Mobility Support*, Jan. 2002. IETF RFC 3220.
- [20] *Data Service Options for Spread Spectrum Systems: Service Options 33 and 66*, May 2006. 3GPP2 Spec., C.S0017-012-A v2.0.
- [21] *Upper Layer (Layer 3) Signaling Standard for cdma2000 Spread Spectrum Systems—Revision D*, Sep. 2005. 3GPP2 Spec., C.S0005-D v2.0.
- [22] *Interoperability Specification (IOS) for cdma2000 Access Network Interfaces—Part 3 Features*, Dec. 2005. 3GPP2 Spec., A.S0013-C v2.0.
- [23] *3GPP2 Access Network Interfaces Interoperability Specification—Revision A*, Jun. 2001. 3GPP2 Spec., A.S0001-A v2.0 (IOSv4.1).
- [24] *Introduction to cdma2000 Spread Spectrum Systems—Revision D*, Sep. 2005. 3GPP2 Spec., C.S0001-D v2.0.
- [25] *Selection Procedures for the Choice of Radio Transmission Technologies of the UMTS*, Apr. 1998. ETSI, TR UMTS 30.03 ver. 3.2.0.
- [26] *1xEV-DV Evaluation Methodology*, Nov. 2001. 3GPP Documents of 3GPP/3GPP2 Joint Meeting on Harmonisation of High Speed Data Service.
- [27] *MPEG-4 and H.263 Video Traces for Network Performance Evaluation*, Dec. 2001. [Online]. Available: <http://www-tnk.ee.tu-berlin.de/research/trace/trace.html>
- [28] M. Chatterjee and S. K. Das, "Optimal MAC state switching for cdma2000 networks," in *Proc. IEEE INFOCOM*, New York, Jun. 2002, pp. 400–406.
- [29] *Requirements for Evolved UTRA (E-UTRA) and Evolved UTRAN (EUTRAN)*, Mar. 2006. 3GPP Spec., Rel. 7, TR 25.913 v7.3.0.
- [30] *Technology Evolution Framework for 3GPP2 Networks: A White Paper*, Oct. 2006. 3GPP2 Spec., SC.R5002-0 v1.0.

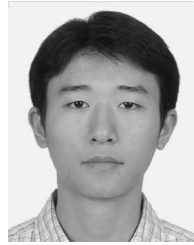

**Jui-Hung Yeh** (S'03) received the Ph.D. degree in 2008 from the National Tsing Hua University, Hsinchu, Taiwan.

He is currently a Postdoctoral Researcher with the Realtek-NCTU Joint Research Center, National Chiao Tung University, Hsinchu, Taiwan. His research interests include QoS, mobility management, integration of wireless networks, and performance evaluation.



**Jyh-Cheng Chen** (S'96–M'99–SM'03) received the Ph.D. degree from the State University of New York, Buffalo, in 1998.

From August 1998 to August 2001, prior to joining the National Tsing Hua University (NTHU), Hsinchu, Taiwan, as an Assistant Professor, he was a Research Scientist with Bellcore/Telcordia Technologies, Morristown, NJ. He is currently a Professor with the Department of Computer Science and the Institute of Communications Engineering, NTHU. He leads the development of WIRE1x, which is one

of the most important implementations of the IEEE 802.1x supplicant. He is a coauthor of the book *IP-Based Next-Generation Wireless Networks* (Wiley, 2004). He has authored over 70 papers. He is the holder of 16 U.S. patents, four R.O.C. patents, and four P. R. C. patents.

Dr. Chen is a Senior Member of the Association for Computing Machinery. He was the recipient of the 2000 Telcordia CEO Award; the 2001 Science Applications International Corporations Executive Science and Technology Council Publication Award; the 2004 NTHU New Faculty Research Award; the 2006 NTHU Outstanding Teaching Award; and the 2007 Best Paper Award for Young Scholars from the IEEE Communications Society Taipei and Tainan Chapters and from the IEEE Information Theory Society Taipei Chapter. He is a Technical Editor of the *IEEE Wireless Communications*. He was a Guest Editor of the IEEE JOURNAL ON SELECTED AREAS IN COMMUNICATIONS, Special Issue on "All-IP Wireless Networks," May 2004. He was the Technical Program Cochair of the Ninth International Federation of Information Processing/IEEE International Conference on Mobile and Wireless Communications Networks (MWCN '07) held in Ireland in September 2007. He was the Technical Program Cochair of the Third IEEE International Conference on Information Technology: Research and Education (ITRE '05). He has been on the technical program committee of numerous international conferences, including the IEEE Conference on Computer Communications (INFOCOM) 2005–2006, the IEEE Global Telecommunications Conference (GLOBECOM) 2005–2008, and the IEEE International Conference on Communications (ICC) 2007–2009. He was a Tutorial Speaker at the IEEE GLOBECOM 2002, 2003, and 2006 in the subject of next-generation wireless networks.



**Chi-Chen Lee** received the M.S. degree from the National Tsing Hua University, Hsinchu, Taiwan, in 2003.

He is currently an Engineer with MediaTek Inc., Hsinchu.